



# CONTENTS

---

<b>1</b>	<b>QUICK START GUIDE (ST097)</b> . . . . .	<b>6</b>
1.1	DEFAULT INPUT OUTPUT CONFIGURATION . . . . .	6
1.2	DEFAULT CONFIGURATION . . . . .	6
1.3	WIRING UP YOUR ZLM1 . . . . .	7
1.4	JUMPERS . . . . .	7
1.5	FREQUENTLY USED LCD KEYPAD COMMANDS . . . . .	8
<b>2</b>	<b>INTRODUCTION</b> . . . . .	<b>9</b>
<b>3</b>	<b>FEATURES AND BENEFITS</b> . . . . .	<b>12</b>
3.1	MORE FEATURES . . . . .	13
<b>4</b>	<b>CONSTRAINTS</b> . . . . .	<b>14</b>
<b>5</b>	<b>SPECIFICATIONS</b> . . . . .	<b>15</b>
<b>6</b>	<b>EQUIPMENT REQUIREMENTS/OPTIONS</b> . . . . .	<b>17</b>
6.1	REQUIREMENTS . . . . .	17
6.2	OPTIONS . . . . .	17
<b>7</b>	<b>DESCRIPTION</b> . . . . .	<b>18</b>
7.1	FRONT PANEL STATUS LIGHTS . . . . .	18
7.2	FRONT PANEL LCD DISPLAY . . . . .	19
7.2.1	DISARMED . . . . .	19
7.2.2	ARMED . . . . .	19
7.2.3	ALARMS . . . . .	19
7.3	KEYPAD (OPTIONAL) . . . . .	20
7.4	INTERNAL BEEPER/KEYPAD BEEPER . . . . .	20
7.5	ARM INPUT (CONTROL INPUT 1) . . . . .	20
7.6	LIGHTNING PROTECTION . . . . .	21
<b>8</b>	<b>CONTROLLING YOUR ZLM1</b> . . . . .	<b>22</b>
8.1	CONTROL ARBITRATION . . . . .	22
8.2	PC CONTROL . . . . .	22
8.3	MOBILE & PC CONTROL (INTERNET ONLY) . . . . .	22
8.4	WEB SERVER . . . . .	23
8.5	KEYPAD . . . . .	23

8.6	CONTROLLING THE ZLM1 USING THE KEYPAD . . . . .	23
8.6.1	KEYPAD VERSIONS. . . . .	23
8.6.2	KEYPAD STATUS DISPLAY. . . . .	24
8.6.3	ARMING/DISARMING USING THE KEYPAD . . . . .	25
8.6.4	WHEN AN ALARM OCCURS . . . . .	26
8.6.5	TO SILENCE AN ALARM. . . . .	26
8.6.6	TO CLEAR ALARM MEMORY . . . . .	27
8.6.7	CHANGING THE PIN NUMBER . . . . .	27
8.6.8	INTERNAL BEEPER/KEYPAD BEEPER . . . . .	28
8.6.9	ZLM1 RELEVANT KEYPAD CODES . . . . .	28
<b>9</b>	<b>INSTALLATION . . . . .</b>	<b>30</b>
9.1	INSTALLATION STEPS . . . . .	30
9.2	JUMPER CONFIGURATION . . . . .	31
9.3	FENCE TERMINALS . . . . .	32
9.4	CONTROL, POWER AND IO TERMINALS . . . . .	33
<b>10</b>	<b>WIRING DIAGRAMS . . . . .</b>	<b>34</b>
10.1	STANDALONE FENCE CONFIGURATIONS . . . . .	34
10.2	LOW VOLTAGE ZONING SYSTEM . . . . .	37
10.3	KEYPAD BUS WIRING. . . . .	38
10.4	EXAMPLE GROUP WIRING DIAGRAM . . . . .	39
<b>11</b>	<b>TECHNICAL INFORMATION. . . . .</b>	<b>40</b>
11.1	LCD ERROR MESSAGES . . . . .	40
11.2	PROGRAMMING OPTIONS . . . . .	40
11.2.1	ENTER PROGRAMMING MODE . . . . .	40
11.2.2	TO EXIT PROGRAMMING MODE . . . . .	41
11.2.3	CHANGING THE INSTALLER PIN . . . . .	41
11.2.4	CHANGING AN OPTION . . . . .	41
11.2.5	PROGRAMMABLE OPTIONS TABLE . . . . .	42
11.3	PROGRAMMING OPTIONS IN DETAIL. . . . .	44
11.3.1	ZONE 1 FENCE VOLTAGE ALARM LEVEL (01xx#) . . . . .	44
11.3.2	MISSED PULSE COUNT (06xx#) . . . . .	44
11.3.3	BATTERY ALARM VOLTAGE (07x#) . . . . .	45
11.3.4	INPUT TYPE (11x#) . . . . .	45
11.3.5	CHIME MODE (14x#) . . . . .	46

11.3.6 AUTO RE-ARM TIME (20x#) . . . . . 46

11.3.7 RELAY FUNCTIONS. . . . . 47

11.3.8 GROUP MODE (26x#) . . . . . 48



# 1 QUICK START GUIDE (ST097)

This quick start guide contains the bare minimum information to get your ZLM1 up and running with useful links to the more in depth information contained in this document.

## 1.1 DEFAULT INPUT OUTPUT CONFIGURATION

Figure 1 below shows the inputs and outputs for the ZLM1 low voltage monitor.

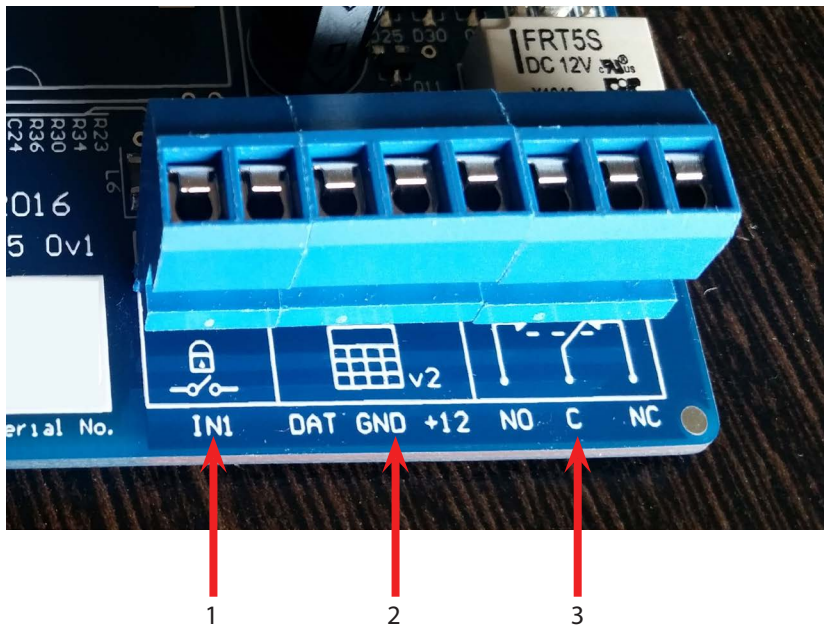

*Default Input Output Configuration*

## 1.2 DEFAULT CONFIGURATION

1. IN1 is configured to arm or disarm the energiser
2. This is where you attach the LCD keypad to program the energiser if the defaults are not the desired values, or, if you want to control the unit from a different location.
3. This is the relay output. By default, the relay is set to switch for a loop fence alarm.

### 1.3 WIRING UP YOUR ZLM1

This is covered under “10 Wiring Diagrams” on page 34. After the ZLM1 has been wired up you can begin to protect your perimeter.

### 1.4 JUMPERS

Jumpers quickly allow you to turn on and off different features, or reset the device to defaults. These are explained in the table below.

JUMPER	FUNCTION	PURPOSE
J2	Enables +12V on the common pin of the relay output.	If you wish to add a siren to the relay that needs to be driven by 12V, add the jumper to J2
J3	N/A	N/A
J4	Factory default jumper  Off to return programmable options to factory defaults on power up.	If the energiser needs to be defaulted to factory settings, remove all power (battery) and remove the J4 jumper. Reapply the battery power. Reapply the J4 jumper and the Energiser will be reset to default settings.
J8	Inhibit internal Beeper	Fitted to inhibit the internal beeper, irrespective of any option setting.

## 1.5 FREQUENTLY USED LCD KEYPAD COMMANDS

For a full list of all keypad commands please see “8.6.9 ZLM1 Relevant Keypad Codes” on page 28.

NOTE: The default user PIN is 1234, and the default installer PIN is 012345.

Function	Key Sequence
Arm/Disarm	[User PIN][#]
Silence an alarm	[User PIN][#]
Start Programming the ZLM1	[Installer PIN][*] [0] [#]
Exit Programming	[*] [#]
Arm All Zones (Multi-zone groups)	[User PIN][*][1][0][#]
Arm Zone x, where x is any zone number up to 15	[User PIN][*][1][x][#]
Disarm all Zones	[User PIN][*][2][0][#]
Disarm Zone x, Where x is any zone number up to 15	[User PIN][*][2][x][#]
Clear Alarm memory	[*] [1] [#]



## 2 INTRODUCTION

---

Thank you for purchasing a JVA security Low voltage monitor. The growing use of non-lethal electric security fences around the world is indicative of the confidence security professionals are placing in this form of perimeter security. The reason for this popularity is simple – monitored electric security fences are effective, economical, simple to install and they offer more D's of security than any other perimeter system:

**DEMARICATION** - The JVA electric fence around your property shows you mean business.

**DEFLECTION** - Intruders are deflected to softer targets.

**DETERRENCE** - The safe, powerful JVA shock is a strong deterrent to intruders.

**DELAY** - The barrier will help delay an intruder, giving you more time to react.

**DETECTION** - The JVA's voltage monitor warns you of any tampering with the fence.

**DEPENDABLE** - 60 seconds a minute, 60 minutes an hour, 24 hours a day, 365 days a year, your JVA electric security fence is monitored by an alert, sober, electronic watchman.

The ZLM1 is a single zone low voltage electric fence monitor. The ZLM1 may be used by itself or in conjunction with a number of high voltage security electric fence energisers. The ZLM1 monitors a single loop of fence wire reaching out up to several hundred meters long, to detect someone tampering with the fence by cutting or shorting the wires. When used in conjunction with a high voltage electric fence energiser the ZLM1 is wired to the non energised earth wires on the fence. The ZLM1 is compatible with the JVA Z series of energisers. It may be connected via a keypad bus network with other Z series devices to enable the whole group to be controlled via one keypad, or linked to a PC running Perimeter Patrol or Cloud Router. The ZLM1 monitors a low voltage loop using intrinsically safe, isolated ELV DC. It employs a continuity check for detecting open circuits, DC voltage level sensing to detect a short to ground and pulse voltage sensing to detect a short to a line powered by a high voltage fence energiser. An additional high voltage isolated port included on the ZLM1 allows for external electric fence voltage monitoring. If paired with a JVA Z series energiser the system can then be synchronised to pulse together with the ex-

ternal system . The advanced features of this device allow the performance to be tuned to the fence and to the particular requirements of the site. This is done by adjusting the devices programmable options. The ZLM1 will report an alarm on seeing a low voltage loop cut (open circuit), shorted to ground (short) or when high voltage from an electric fence energiser wire is shorted to the monitored low voltage loop. Designed and manufactured to meet the most stringent international safety standards, the JVA ZLM1 is in a class of its own when it comes to features and benefits at an affordable price.



Australian designed and manufactured	High reliability and great service
Programmable options	Customise the low voltage monitor to unique fence conditions
Wall-mountable, robust enclosure with easily detachable PCB chassis.	Ease of installation and repair
Optional 4 Line or LCD keypad	Ease of control and Display of fence voltages
Optional PC and internet connections	Integration with Security Information Management systems
Optional Touch keypad	Touch keypad with fluid, familiar user interface for even easier fence control, monitoring and programming of your security low voltage monitor.
Single "Form C" Relay with dry contacts for switched voltage Output	Can be switched based on alarm triggers or input states.

## 3.1 MORE FEATURES

- Monitors for continuity using safe 50V DC pulses.
- Can detect a short to ground, high voltage short and open circuit (fence cut)
- Alarms for fence short (Low Voltage wire connected to ground), Open circuit (if the low voltage wire has been cut) and High voltage short (if the low voltage wire is touching a High voltage wire).
- Internal Beeper
- Low Battery and Bad Battery Detection
- Large number of keypad programmable options
- Single Control Input can be configurable as NO (Normally Open) or NC (Normally Closed) contacts
- Able to be integrated into third party access control and security information management systems at a variety of levels
- Enables the construction of systems from economical Key switch operation to complex PC controlled applications
- Runs from 12V DC external source
- Fence connections are fully isolated from power and IO as per relevant parts of IEC60335.2.76

## 4 CONSTRAINTS

- Any energiser used with the ZLM1 must comply with IEC60335.2.76 electrical safety standard. All JVA energisers under 18J output are suitable.
- Energisers with a negative voltage are not suitable
- The energiser output pulse energy must not exceed 18 Joules
- The maximum series resistance of the fence wire loop which can be accurately monitored is 5000 Ohms
- Since the ZLM1 is a relatively new addition to the JVA Z series, older versions of TCP/IP adaptors, GPIO, Wi-Fi and GSM gateways may not be compatible with it. Please contact your distributor or store to get the latest versions.
- The JVA LCD keypad (PTE0210) requires version 2.12 or later firmware to operate with a ZLM1, the keypad firmware can be viewed by at power up or by pressing \*9# on the keypad.
- Perimeter Patrol version 5.2.2 or later is required to operate with a ZLM1

## 5 SPECIFICATIONS

The specifications table below outlines the power consumption of the ZLM1 and the acceptable voltage and current ranges for different inputs and outputs.

Nominal input voltage	14.2Vdc
Power consumption of ZLM1 (Note 1)	63mA at 12.5 Vdc
Maximum voltage on “In1” input (Note 2)	5Vdc
Maximum Energiser Joules (Note 3)	18J
Maximum loop impedance	5000 Ohm
Maximum loop capacitance to ground	1.0uF
Minimum loop resistance to ground	1000 Ohm
Maximum external HV measurement voltage (Note 4)	10,000v

**NOTE 1:** This is the power consumption when none of the powered outputs are active and the keypad is not connected. The rated power consumption may be lower depending on relay configuration and alarm states.

**NOTE 2:** The control inputs as supplied with 5V from a “weak pull up” circuit so that they can be controlled using dry contacts from a relay or switch. A device with “open collector” outputs may be used. They can also

be driven from a 5V switched output, so long as the driving circuit actively pulls down to ground when off.

**NOTE 3:** This is the maximum rating of the energiser if the ZLM1 is used on the same fence as a high voltage electric fence energiser. Beyond this rating the ZLM1 loop circuit protection MOV's may fail if high voltage wires are shorted to the ZLM1 loop wires.

## **WARNING!**

- There are no user-serviceable parts in this unit.
- Before working on the high voltage wiring of an electric fence, it is recommended that the energiser be turned off and an intentional short circuit be placed from the fence live wires to earth.
- Electric fences are not toys; do not let children play with them.



## 6 EQUIPMENT REQUIREMENTS/OPTIONS

### 6.1 REQUIREMENTS

- External 12V source

### 6.2 OPTIONS

- 12V Siren or strobe light
- 4 Line Keypad (PTE0240) or LCD Keypad (PTE0210). Note 1,2
- Cloud Router Web Application
- Windows PC
  1. Windows XP or later
  2. PAE223 or PAE100 serial adaptor AND USB to serial adaptor
  3. or PAE212 TCP/IP adaptor
  4. Perimeter Patrol PC application

#### Notes:

1. While the Keypad is not essential for normal operation, it is required to adjust the programmable options.
2. Up to 3 Keypads may be connected in parallel on a ZLM1, each Keypad must have a unique keypad address.

For more information please see [www.jva-fence.com.au](http://www.jva-fence.com.au)

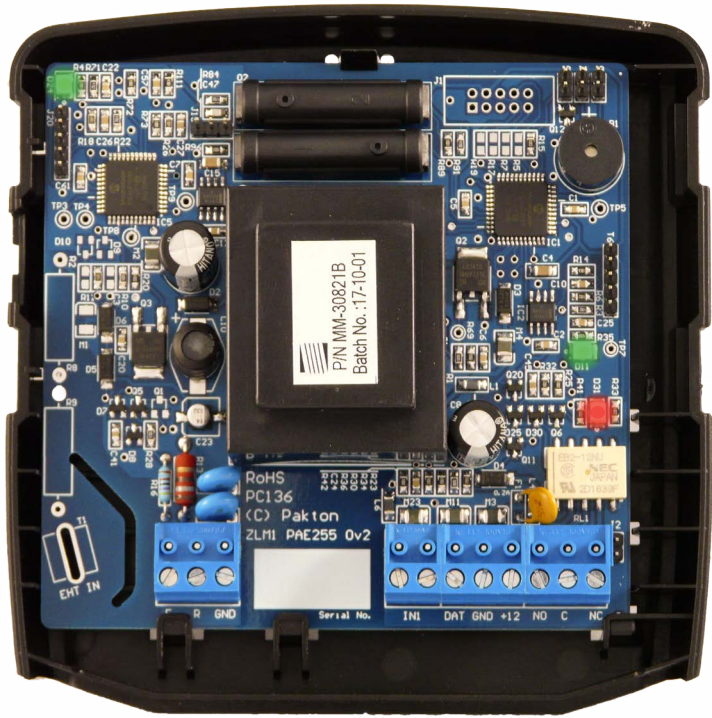

## 7.1 FRONT PANEL STATUS LIGHTS

The status LED's on the front of the ZLM1 allow the user to quickly ascertain the current status of the unit and if any action needs to be taken. Below is a brief description of each LED and the information it conveys.

LED NAME	LOCATION	PURPOSE
Isolated Power	Top Left	On when the unit is armed (pulsing)
Main Power	Middle Right	On whenever the unit has power
Relay Activation	Bottom Right	On when the relay is turned off

## 7.2 FRONT PANEL LCD DISPLAY

The detachable 16 character, two-line display of the ZLM1 clearly shows the status of the fence it is connected to at a glance. If you have an LCD keypad attached you can press the # key to freeze the current displayed information. It will resume after 10 pulses have occurred. Alternatively you can continue to press the # key to iterate through the displays at your own pace.

### 7.2.1 Disarmed

When the unit is disarmed you will see the following display. In a disarmed state it can also display any alarms it detected when it was last armed. This is explained in greater detail below.

```
JVA ZLM1
DISARMED
```

### 7.2.2 Armed

When armed, it cycles through a number of displays .

```
LOOP: 47V
```

```
ZLM1 ARMED
ALL CLEAR
```

```
INPUT:14.5V
```

### 7.2.3 Alarms

When a fence alarm occurs additional screens will be added to both the Armed and disarmed state screen rotations. Below Zone 1 has been shorted to ground, cut and then it has been shorted to a HV wire (only occurs when paired with another Z series energiser). It also shows a battery alarm.

```
ALARM
GND SHORT
```

```
ALARM
FENCE CUT
```

```
ALARM
HV SHORT
```

```
ALARM
BAD/NO BATTERY
```

Note: Not all models support an LCD display.

### 7.3 KEYPAD (OPTIONAL)

A keypad (either 4 Line, Touch or LCD) can be used to remotely monitor and control the ZLM1. It is also used to set the programmable options. For more on programming the device see “11.2 Programming Options” on page 40.

### 7.4 INTERNAL BEEPER/KEYPAD BEEPER

Depending on the chime setting, the internal beeper and keypad beeper will sound when there is a fence alarm or a general alarm.

### 7.5 ARM INPUT (CONTROL INPUT 1)

The JVA Z series energiser can be armed (to energise the fence) by closing a contact wired into the arm input.

## 7.6 LIGHTNING PROTECTION

Although the ZLM1 contains internal lightning protection elements, external lightning protection systems such as additional external lightning protection kits are recommended to further reduce lightning damage and thus reduce repair costs. Ask your installer for Lightning protection for your fence!

## 8 CONTROLLING YOUR ZLM1

- Your JVA ZLM1 security low voltage monitor has been designed for ease of operation. The ZLM1 may be armed and disarmed using any of the following:
- Key switch or remote switch connected to the control input (IN1)
- Remote control radio receiver connected to IN1
- Z Series Keypad (4 Line, LCD or Touch)
- JVA Webserver \*not all versions
- JVA GSM module \*not all versions
- PC or Smart Phone running JVA Cloud Router. \*need internet
- Windows PC running JVA Perimeter Patrol
- Low level interface (wired to control inputs and relay outputs) from a third part security alarm panel or Physical Security Information System (PSIM)

Note: More than 1 method may be used in the one installation.

### 8.1 CONTROL ARBITRATION

If an installation contains two ways to control the ZLM1, then the most recent control signal will determine the Armed/Disarmed state. For example if the ZLM1 is armed via the keypad and then disarmed at the control input (IN1) it will disarm.

The higher level control methods such as the Webserver, GSM and PC control software may override the Control input and Keypads methods, depending on the options used. If you need to make sure that fence is disarmed (for maintenance) then using the keypad alone may not guarantee that the fence will remain disarmed.

### 8.2 PC CONTROL

A standard Windows PC may be used to control and monitor a group of Z-Series energisers as well as other JVA equipment. Ask your JVA installer for a demonstration of Perimeter Patrol™ software.

### 8.3 MOBILE & PC CONTROL (INTERNET ONLY)

Any smart phone, Apple or Windows PC may be used to control and moni-

tor a group of Z-Series energisers as well as other JVA equipment. Ask your JVA installer for a demonstration of Cloud Router or visit [www.cloudrouter.pakton.net](http://www.cloudrouter.pakton.net)

## 8.4 WEB SERVER

Another alternative to remotely controlling JVA Z-Series energisers is to use the PAE225 Webserver. When suitably configured this allows the energiser to be controlled and monitored via a web browser from any internet connected device anywhere in the world.

Note: The ZLM1 is not supported by older versions of the webserver.

## 8.5 KEYPAD

The ZLM1 and other devices connected on the same keypad bus can be controlled via a keypad. For more information see “8.6 Controlling the ZLM1 using the Keypad” on page 23.

## 8.6 CONTROLLING THE ZLM1 USING THE KEYPAD

The low voltage monitor can be installed in a convenient location close to the fence, while the keypad can be positioned in an easily accessible place. The systems status information, e.g. mains power, energiser on/off, fence voltages, fence alarm, auxiliary alarm, etc., are displayed on the keypad. If a keypad is connected, the control input terminal may not be operational as they may have been disconnected by the installer. For a full description of operating the Keypad see the keypads manual.

This keypad requires a Wi-Fi or GSM Gateway.

### 8.6.1 Keypad Versions

The current version keypad is a PTE0210 with code version 2.00. Older versions have limitations. The keypad version can be seen by pressing \*9#.

PTE0210 Shows “PTE0210” and the code version.

- Can show fence voltages
- Will respond to \*68# to analyse the “group”.
- Version 1.21 and below
- Older version, can be upgraded to V2.00 firmware.
- Cannot detect or operate with the ZLM1.
- Version 2.20 and higher

- ZLM1 is supported.

#### PTE0230 Touch screen keypad

- Provides the most advanced monitoring and control of all Z-Series devices
- All functions are available
- Refer to the inbuilt help, the rest of this chapter refers to the simpler LCD keypads above.

#### PTE0240 4 line keypad

- The 4 line keypad has the same functionalities as the PTE0210 keypad and more.
- The main difference is the support of our newest energizers.

### 8.6.2 Keypad Status Display

In normal operation the keypad shows a continuous summary of the system status. For example if the system is disarmed the keypad will display “Ready to Arm”. If the system is armed then the keypad will display the voltages for each zone in the system. Since there can be many things to display the keypad automatically “scrolls” through all relevant information. Each screen is shown for about 2 seconds. If you wish to hold the display at a particular point simply press the [#] key. The auto scrolling will stop for about 20 seconds. Pressing the [#] key again will advance the display one step. If a new trouble (AC fail, low battery etc) or alarm occurs, the keypad screen will jump to the relevant zone, the keypad will beep (unless toggled off) and auto scrolling will cease for about 3 minutes.



### 8.6.3 Arming/Disarming Using the Keypad

- Enter your PIN number (four digits long) and push the # key. (Default is 1234).
- Make sure the red ARM light comes on.
- The keypad will beep twice to confirm that the system is armed.
- The fence will power up and if all is well (no faults) the system will be ready to deter and detect.
- If there is a fault on the fence and it cannot achieve full voltage, the LCD screen will indicate that there is a fault.
- To disarm the system, enter your PIN and press #.

### 8.6.4 When an Alarm Occurs

An Alarm will occur if there is a fault on the fence caused by a short or an open circuit (cut), while the system is armed. The internal beeper and the Keypad may sound, depending on how your system is configured.

There are 3 ways the ZLM1 can detect a fence fault:

1. The low voltage fence is cut (open circuit)
2. The low voltage fence is shorted to ground (LV short)
3. A high voltage wire shorts to a low voltage wire (HV Short)

Note: If the ZLM1 is monitoring a fence that has a disarmed energiser on it, a ground alarm will occur when one of the HV wires touches a LV wire. This is because the ZLM1 pulse will ground through the energisers transformer. Whilst the ZLM1 is correct in stating that there is a ground short, please be aware of this when diagnosing fence faults.

If the system is armed and the fence is tampered with, the Relay LED will flash and then remain on. A siren or strobe connected to the unit will turn on. If the energiser is connected to an alarm system for monitoring, an alarm signal will be sent to the alarm company monitoring the alarm system.

The Relay LED will only turn on if it is programmed to the specific fence alarm.

### 8.6.5 To Silence an Alarm

- Enter your PIN (default is 1234) and press #. This will silence the alarm but not disarm the system; the Armed Light will still be on. The system will be ready for the next alarm. (Note that the following functions have an effect on alarm timing: Siren On time, Siren Off time, Siren Cycles, Auto Re-arm time).
- The siren and strobe are ready to respond again if triggered.
- To disarm the system, enter your PIN and press # again. This will also clear the fence alarm light.
- Alternatively, disarming using input switch will reset the alarm.
- If you silence an alarm and the problem is still present when the unit is rearmed, the siren will sound again after the programmed off time has elapsed.

### **8.6.6 To Clear Alarm Memory**

After an alarm occurs, pressing \*1#, will clear the alarm memory. If the problem still exists the unit will alarm again.

### **8.6.7 Changing the PIN Number**

- Enter the old PIN (default is 1234) and press \*0#. This enters User Programming mode.
- Enter your new PIN (must be 4 digits) and then #. (Repeat to confirm PIN.)
- Press \*# to exit User Programming mode.
- Make sure your new PIN works by using it to arm the energiser or monitor.

## 8.6.8 Internal Beeper/Keypad Beeper

Depending on the Chime Mode setting, the internal beeper and keypad beeper will sound when there is a fence alarm, a gate alarm, a general alarm or a door chime. On flat battery the keypad will always beep 4 times before the energiser or monitor automatically enters low power mode to preserve the battery.

Note: The Internal beeper also beeps at Power up.

## 8.6.9 ZLM1 Relevant Keypad Codes

The default user pin is 1234. The default installer pin is 012345.

Function	Key Sequence
Arm/Disarm	[User PIN][#]
Silence an alarm (Single zone system only)	[User PIN][#]
Start Programming the Z-Series energiser or monitor	[Installer PIN][*] [0] [#]
Start Programming the Keypad	[Installer PIN][*] [0] [1] [#]
Exit Programming (any mode)	[*] [#]
Change a User PIN	[User PIN][*][0][#][New PIN]#
Change the Installer PIN	[0] [0] [New Installer PIN][#]
Arm All Zones (Multi-zone groups)	[User PIN][*][1][0][#]
Arm Zone 1 (Master)	[User PIN][*][1][1][#]
Arm Zone x, where x is any zone number up to 15	[User PIN][*][1][x][#]
Disarm All Zones	[User PIN][*][2][0][#]
Disarm HV Zone 1 or Master	[User PIN][*][2][1][#]

Function	Key Sequence
Disarm Zone x, where x is any zone number up to 15 (Note 1)	[User PIN][*][2][x][#]
Arm Gate circuits only	[User PIN][*][4][#]
Keypad Audible Feedback Toggle	[*] [5] [1] [#]
Keypad Chimes Toggle On Off	[*] [5] [3] [#]
Keypad Error Tones Toggle On/Off	[*] [5] [4] [#]
Keypad Alarm Tones Toggle On/Off	[*] [5] [5] [#]
Backlight Toggle On/Off	[*] [8] [#]
Display Keypad Model	[*] [9] [#]
Analyse Group	[*][6][8][#]
Reset and Display firmware version number	[User PIN][*][6][8][#]
Reset and return to factory defaults	[Installer PIN][*] [6] [8] [#]
Siren test	[*] [6] [3] [#]
Battery test	[*] [6] [4] [#]
Clear Alarm memory	[*] [1] [#]

## 9 INSTALLATION

It is recommended that all installations are performed by qualified technicians.

### 9.1 INSTALLATION STEPS

1. Read the entire ZLM1 and Energiser manuals first!
2. Design and build the fence. (Beyond the scope of this manual.) Ask your distributor for help if required.
3. Decide where the energiser, ZLM1 and Keypad are to be mounted. If on an external wall it should be housed within a weatherproof equipment box, shaded from direct sun.
4. Remove the ZLM1 PCB chassis from the housing by depressing the top mounting clip and tilting the PCB towards yourself.
5. Mount the housing by using 2 screws through the rear of the box. The box must be mounted to a wall in such a way that both holes in the rear of the case are against the mounting surface. Do not mount to a conductive surface. If you do so the insulation required under IEC60335.2.76 may be lost.
6. Replace the PCB chassis.
7. If using a keypad, remove the rear housing of the keypad and fix it to the wall.
8. Wire the low voltage cables to the PCB terminals.
9. Wire the high voltage cable to the PCB terminals.
10. Set the Jumpers as required
11. Fit the input power leads to the power source.
12. Replace the front cover (lid).
13. Turn the power source on.
14. Arm the ZLM1 and Switch on the Energiser if used. If an LCD display is connected, it will now show the zone voltages.
15. Find and remove any faults on the fence.
16. Test that a short on the fence puts the ZLM1 into alarm and shows a short alarm on the keypad.
17. Test that a cut on the fence puts the ZLM1 into alarm and shows a cut alarm on the keypad.

## 9.2 JUMPER CONFIGURATION

The ZLM1 is equipped with four jumpers, the first (J2) is used to provide 12V to the relay. J3 and J4 operate in an identical fashion to those on the Z14. The third jumper, J8 will suppress the beeper on the ZLM1 when fitted.

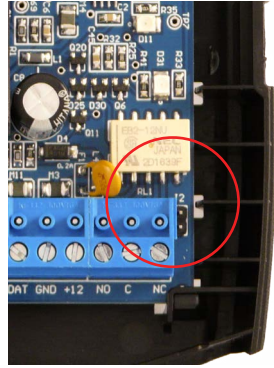
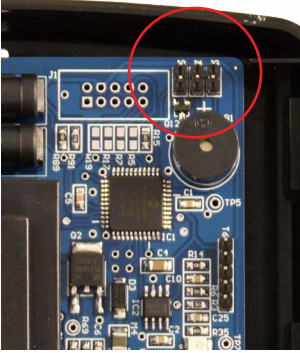

For Jumper features, refer to Figure 1.4 on page 7.

## 9.3 FENCE TERMINALS



Description of fence terminals (Left to Right)

EHT IN	Connect to external electric fence.
F	Connect to fence loop in.
R	Connect to fence loop return.
GND	Connect to main fence earth stakes.

Note: Not all models have EHT input terminal.



## 9.4 CONTROL, POWER AND IO TERMINALS



Label	Type	Description
IN1	2 Way	Energiser control input (dry contact). Defaults to normally open.  Can be used for a remote switch or a radio receiver. The receiver may be powered from the keypad +12V terminal.
Keypad	3 Way	Used as power input and data line for an external keypad. The unit is protected from over current by a 0.2A self resetting fuse.
Relay 1	3 Way	May be set to any of 16 alarm conditions. Defaults to zone 1 alarm. Dry contact or 12V



- Insulated wire woven through balustrade or chainmesh fencing. The alarm is given if the insulated wire is cut or shorted to earthed metal.

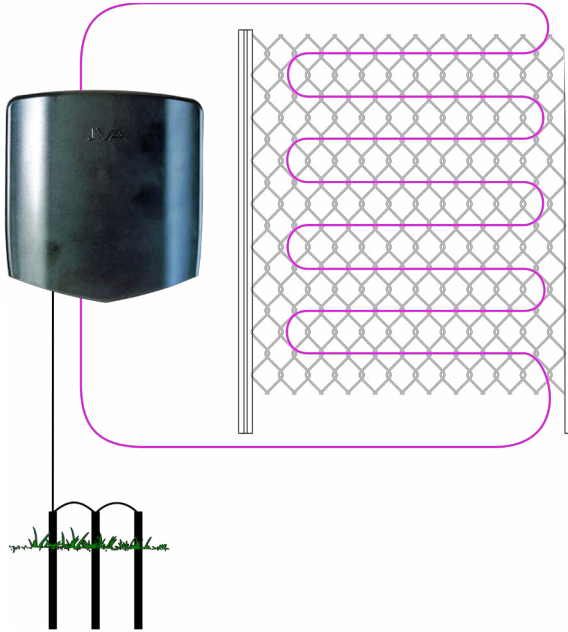

- Insulated wire buried underground. The alarm is given if the insulated wire is cut or shorted to earth.

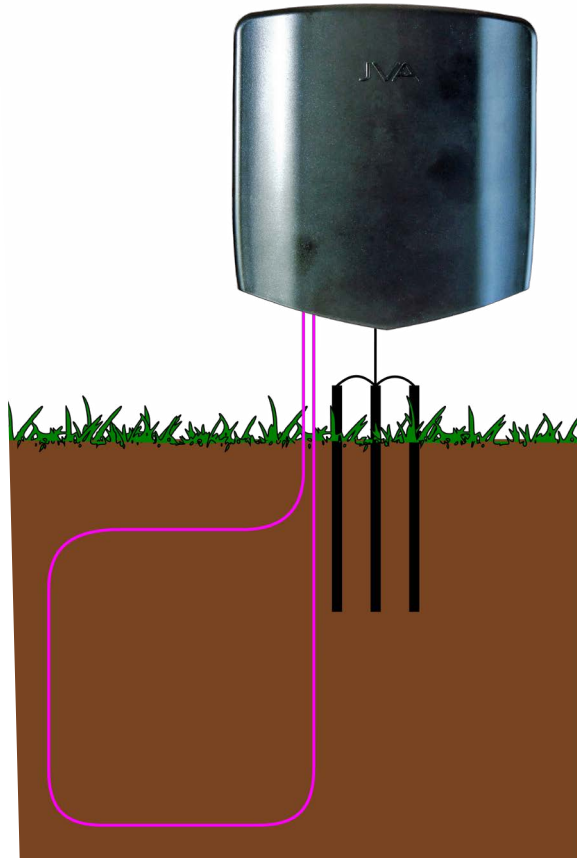

## 10.2 LOW VOLTAGE ZONING SYSTEM

A ZLM1 can be combined with JVA Z series energisers which provide the main deterrence. The ZLM1 provides fence monitoring by using extremely low voltage pulses on the unused wires on a fence. Below shows how the fence might be configured for monitoring. In this configuration the ZLM1 must be configured as a slave and the Z series energiser as the master. As noted previously under “4 Constraints” on page 14, the Z series energiser must not exceed 18 Joules. The amount of Z series devices that can be connected together in a group is limited by the ID numbers when using the keypad bus. This limitation is removed if using TCP/IP.

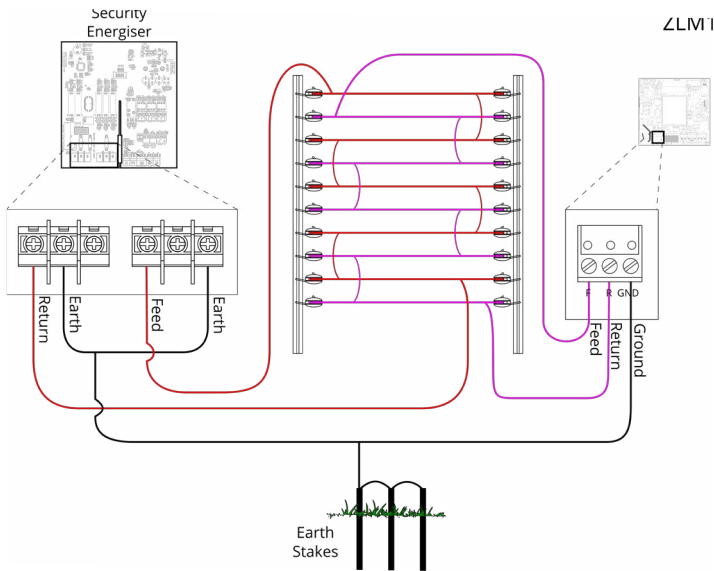

## 10.3 KEYPAD BUS WIRING

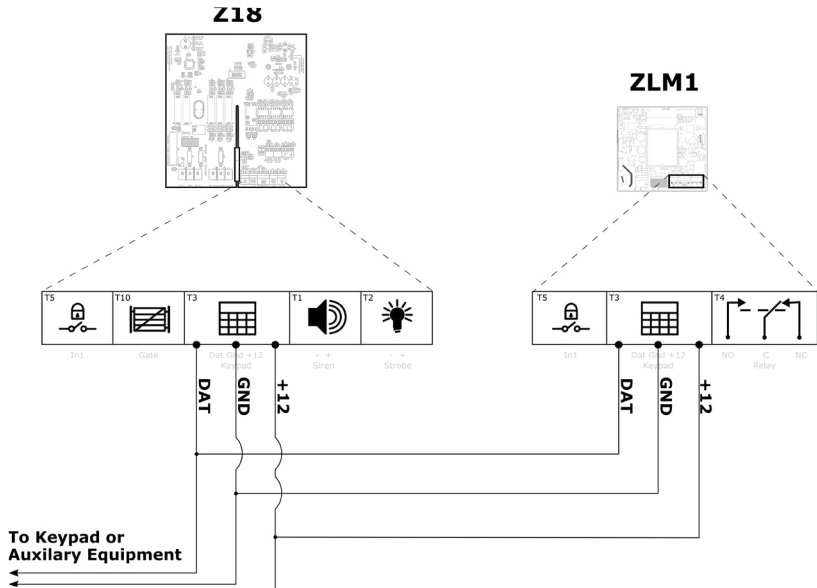

- Set the Group ID of the Z18 to Master (2601#)
- Set the Group ID of the ZLM1 to Slave 1 (2602#)

The Group ID of the ZLM1 must be 1 value higher than the Group ID of the Z-Series Energiser driving it

A ZLM1 by itself does not require the Group ID to be configured as it is factory set to Stand-Alone mode

## 10.4 EXAMPLE GROUP WIRING DIAGRAM

Z28 and two ZLM1 connected to Perimeter Patrol through a PAE223 (USB Interface)



- Set the Group ID of the Z28 to Master (2601#)
- Set the Group ID of the first ZLM1 to Slave 1 (2602#)
- Set the Group ID of the second ZLM1 to Slave 2 (2603#)

# 11 TECHNICAL INFORMATION

## 11.1 LCD ERROR MESSAGES

NOTE: The detachable LCD screen must be connected upon power up or reset to display messages.

The ZLM1 has the ability to display error messages. At start up if any of the Power On Self Tests (POST) fail an error message will be displayed after the version number. If these are “non-fatal” the ZLM1 will continue through start-up and be ready to run.

After any “fatal” error the LCD will now show a number which will aid in fault finding.

LCD Error Message	Meaning
“Fatal” errors	These will stop the unit
Er-11	Memory CRC error
Er-16	Slave Energiser cannot see the Master Energiser via Keypad Bus
Er-17	Isolated processor not responding
Self test errors	Use keypad sequence 2# to show
Er-21	Check Opto circuit 1

## 11.2 PROGRAMMING OPTIONS

Like the Z series of security energisers, the ZLM1 has non-volatile memory in which programming options (or setup parameters) can be stored. These are factory pre-set (defaults), but can be field programmed using a keypad.

NOTE: The default installer PIN is 012345.

### 11.2.1 Enter Programming Mode

To enter programming mode, enter the 6 digit installer PIN followed by \*0# keys. The keypad will beep twice to indicate that the command was accepted. If the PIN was incorrect the keypad will beep 3 times. The LCD on the ZLM1 will now show the first programming option and its current setting.

Pressing the # key will cycle through all the options on the LCD.

NOTE: Not all numbers are used. Not all models support LCD display.



### 11.2.2 To exit programming mode

To exit programming mode press \*#. If left unattended the ZLM1 will time out and auto exit after approximately 5 minutes.

### 11.2.3 Changing the installer PIN

The installer PIN may only be changed while in programming mode.

To enter a new installer pin, press 00 followed by the new 6 digit PIN, then the # key.

If you cannot remember your installer or user PIN, return the ZLM1 memory to default. To do this, remove power (Disconnect keypad bus/power input), open the ZLM1 enclosure, remove jumper J4 and reconnect the power for about 10 seconds. Do not forget to re-fit J4.

This will return all options to the factory set defaults.

### 11.2.4 Changing an Option

The options have possible values in the range of 0 to 99, some are limited to lower maximum values.

To change an option value, first check the option number (see table below) and then the table of values for that option. On the Keypad, press the option number followed by the required value.

For example, to change option 1 to the maximum press 0140#, the keypad will beep twice to indicate that the command was successful. The Energiser LCD will immediately show the updated value.

As the keypad bus is common to a group of Z-Series Energisers and ZLM1 units, one keypad could be used to program all connected units at the same time. A Group containing Z-Series Energisers and ZLM1 units **MUST NOT** get programmed this way as the ZLM1 contains different Option values to the Z-Series Energisers. Each ZLM1/Energiser will need to be isolated from the Group Wiring and programmed individually.

### 11.2.5 Programmable Options Table

Option	Function	Default	Description
01	Voltage alarm level zone 1	20V	Sets the voltage below which the fence alarm will occur. If the return voltage falls below this level for more than the Missed pulse count a fence alarm (zone 1) will occur.
02	Not Used	0	
03	Not Used	0	
04	Not used	0	
05	HV sensitivity	75	0-99%. Setting 0 turns HV alarms off (yet to be implemented)
06	Missed Pulse Count	3	Sets the number of pulses which may be missed before the alarm is activated
07	Battery Alarm Voltage	2 (10V)	Sets the battery voltage threshold below which the general alarm will activate
08	Not Used	0	
09	Not Used	0	
10	Not Used	0	
11	Input type	0 (N/O)	Allows the control input (IN1) to be changed from normally open to normally closed.
12	Not Used	0	
13	Not Used	0	
14	Chime Mode	2 (siren)	Allows the keypad and internal beeper function to be altered
15	Not Used	0	
16	Binary Options	0	Not Used
17	Not Used	0	

Option	Function	Default	Description
18	Not Used	0	
19	Not used	0	
20	Auto Rearm Time	0	Sets the time which must elapse after an alarm has timed out (completed the siren cycles) before the unit will automatically re-arm ready for the next alarm event.
21	Relay	0	Used to assign an alarm function to relay (Zone 1 alarm)
22	Not Used	0	
23	Not Used	0	
24	Not Used	0	
25	Not Used	0	
26	Group ID	0	If used as part of a group, this sets the device ID
27	Not Used	0	

## 11.3 PROGRAMMING OPTIONS IN DETAIL

### 11.3.1 Zone 1 Fence Voltage Alarm Level (01xx#)

Sets the voltage below which the zone alarm will occur. If the fence voltage measured at the return “R” loop terminal falls below this level for more than the Missed pulse count a fence alarm (zone 1) will occur. The value is set directly, not via a table.

For example to set a threshold of 25V enter: 0 1 2 5 #

Setting this option to 0 effectively turns off fence voltage monitoring.

Warning: Setting this level to higher than the normal running voltage of the fence will result in continuous fence alarms.

Value (x)	Alarm Level
Minimum	
0	0.0 V
Default	
20	20 V
Maximum	
40	40 V

### 11.3.2 Missed Pulse Count (06xx#)

This option enables the pulse count to be varied from the default (3). This is the number of bad or missing pulses that are counted before the alarm occurs.

**NOTE:** The lower this option is set the more likely you are to get false alarms.

The value is set directly. For example to set a threshold of 2 bad or missing pulses enter: 0 6 0 2 #.

Value (x)	Missed Pulses
0	1
1	1
2	2
3	3

4	4
5	5
6	6
7	7
8	8
9	9

### 11.3.3 Battery Alarm Voltage (07x#)

This option sets the battery voltage threshold below which the general alarm will activate. The default Battery Alarm Voltage is 10.0 Volts. This alarm can be set to activate one of the relays, and is part of the General alarm.

Value	Alarm
0	9.0 V
1	9.5 V
2	10.0 V
3	10.5 V
4	11.0 V
5	11.5 V
6	12.0 V
7	12.5 V
8	13.0 V
9	13.5 V

### 11.3.4 Input Type (11x#)

The control inputs can be inverted.

Unless an input is used for a Gate switch, in which case it is always NC.

Value (x)	Input type
0	NO Normally open
1	NC Normally Closed

### 11.3.5 Chime mode (14x#)

This option allows the keypad beeper to be used as a door chime for the gate switch.

When set to None, the keypad beeper is used to indicate correct keypad operation only.

The Door Chime is **NOT** used.

The Siren is **NOT** used.

The Gate beeps plus Siren is **NOT** used.

Value	Function
0	None
1	Door Chime
2	Siren
3	Fence Alarm
4	Gate beeps plus Siren

### 11.3.6 Auto Re-Arm time (20x#)

This option sets the time which must elapse before another alarm will sound after the first alarm has timed out (gone completely through its cycles).

If an event occurs which triggers an alarm, any other events which would otherwise trigger the alarm will be ignored while the alarm is sounding and until after the Auto re-arm time has passed.

A setting of 9 will disable auto re-arm.

The default is 0 Seconds (Immediate).

Value (x)	Function
0	0 Seconds (immediate)
1	30 Seconds
2	1 Minutes
3	2 Minutes

Value (x)	Function
4	3 Minutes
5	4 Minutes
6	5 Minutes
7	6 Minutes
8	7 Minutes
9	Disabled – Do not auto rearm

### 11.3.7 Relay Functions

The Relay can be set to any of the available functions (user assignable).

Relay 1 is (21x#)

Defaults for the ZLM1

- Relay 1 – Zone 1 Alarm (0)

Value (x)	Mode
0	Zone 1 alarm
1	Un-used
2	Un-used
3	Un-used
4	Armed
5	Un-used
6	Any Zone alarm
7	General
8	Un-used
9	Un-used
10	Un-used
11	Low / Bad Battery
12	Un-used
13	Un-used
14	Un-used
15	Un-used

Function	Logic for alarm state (opposite of normal state)
Zone 1 Alarm	<p>The ZLM1 is Armed AND</p> <p>Any zone alarm occurs, these include:</p> <p>The loop return Voltage has fallen below the Fence Voltage Alarm Level (Low Voltage)</p> <p>High voltage has been detected (shorted to high voltage wires)</p> <p>For more Energiser pulses than the Missed Pulse Count setting. Not latched.</p>
Armed	The ZLM1 is Armed
General	Tamper OR Low Battery OR Internal Error. Latched for internal errors only.
Battery	Alarm on low or bad input voltage

### 11.3.8 Group Mode (26x#)

A group must have only 1 master. The other Energisers/Monitors in the group are slaves.

The correct procedure is:

Connect the keypad to each Energiser/ZLM1 in turn, programming each Option as required before linking the Keypad bus into a group.

The ZLM1 should only be a group master if there are no Z energisers in the group. I.e. the group is made up of one or more ZLM1 units only.

If a PAE212 TCP/IP adaptor is used, it is the group master. All other devices should be set to slaves.

All energisers must be synchronised, therefore non-synchronised agricultural energiser must never be used in a system with a ZLM1. This allows the ZLM1 pulses to be synchronised with other ZLM1 units or Z-Series Energisers.

Value (x)	Mode
0	No Group



Value (x)	Mode
1	Master
2	Slave 1
3	Slave 2
4	Slave 3
5	Slave 4
6	Slave 5
7	Slave 6
8	Slave 7
9	Slave 8
10	Slave 9
11	Slave 10
12	Slave 11
13	Slave 12
14	Slave 13
15	Slave 14



DEALER

Electric Fencing Products



[WWW.JVA-FENCE.COM](http://WWW.JVA-FENCE.COM)