



Z25 USER MANUAL



CONTENTS

1	QUICK START GUIDE	6
1.1	CHANGING THE PROGRAMMING OPTIONS	6
1.1.1	RELAY FUNCTIONS.	10
1.2	SUMMARY OF KEYPAD FUNCTIONS	13
1.3	JUMPERS	16
1.4	QUICK TEST OF CONFIGURED UNIT.	16
1.5	CONNECTING YOUR Z25 TO THE FENCE.	18
2	INTRODUCTION.	20
3	FEATURES AND BENEFITS	22
3.1	MORE FEATURES	23
4	DESCRIPTION.	24
4.1	JVA Z25 - EXTERIOR	24
4.2	FRONT PANEL STATUS LIGHTS.	25
4.3	FRONT PANEL LCD DISPLAY	25
4.4	INPUTS AND OUTPUTS	25
4.5	KEYPAD (OPTIONAL)	25
4.6	Z-SERIES MODELS.	26
4.7	Z-SERIES LCD KEYPAD (OPTIONAL)	26
4.8	INTERNAL BEEPER/KEYPAD BEEPER	27
4.9	PROGRAMMABLE OPTIONS	27
4.10	ARM INPUT AND KEY SWITCH	27
4.11	GATE INPUT	27
4.12	LOW POWER MODE	27
4.13	AGRICULTURAL MODE	28
4.14	GROUP SIMULTANEOUS PULSE FEATURE	28
4.15	REMOTE CONTROL UNIT (OPTIONAL)	28
4.16	CABLING	28
4.17	LIGHTNING PROTECTION	29
4.18	EARTH LOOP MONITORING	29
4.19	NOISE AND INTERFERENCE	29
4.20	PC CONTROL	29
5	INSTALLATION	30

5.1	INSTALLATION STEPS	30
5.2	INTERIOR CONFIGURATION	31
5.3	EXAMPLE OF FENCE WIRING	32
6	CONTROL	33
6.1	MAGNETIC PROXIMITY SWITCH	33
6.2	ARMING THE FENCE USING THE KEYPAD.	33
6.3	ACTIVATING LOW POWER MODE	34
6.4	WHEN AN ALARM OCCURS	34
6.5	TO SILENCE THE ALARM	34
6.6	CHANGING THE USER PIN	35
6.7	STANDBY BATTERY	35
6.8	STATUS LIGHT	35
7	TECHNICAL INFORMATION.	36
7.1	POWER OPTIONS	37
7.2	STATUS CODES	38
7.3	JUMPERS	38
8	PROGRAMMING OPTIONS	40
8.1	PROGRAMMING MODE	40
8.2	TO EXIT PROGRAMMING MODE.	40
8.3	CHANGING THE INSTALLER PIN	40
8.4	CHANGING AN OPTION	40
8.5	PROGRAMMING OPTIONS IN DETAIL.	41
8.5.1	OUTPUT POWER LEVEL (OPTION 1).	41
8.5.2	LOW POWER MODE OUTPUT VOLTAGE (OPTION 2)	41
8.5.3	FENCE RETURN 1 ALARM VOLTAGE (OPTION 3)	42
8.5.4	FENCE RETURN 2 ALARM VOLTAGE (OPTION 4)	42
8.5.5	FENCE RETURN ALARM VOLTAGE FOR LOW POWER MODE (OPTION 5)	42
8.5.6	MISSED PULSE COUNT (OPTION 6)	42
8.5.7	SIREN ON TIME (OPTION 8).	44
8.5.8	SIREN CYCLES (OPTION 10)	45
8.5.9	GATE ENTRY/EXIT DELAY (OPTION 13)	46
8.5.10	CHIME MODE (OPTION 14)	46
8.5.11	COMBINED OPTIONS (OPTION 16)	47

8.5.12	ANTI-BRIDGING THRESHOLD (OPTION 17)	48
8.5.13	COMBINED OPTIONS 2 (OPTION 18)	48
8.5.14	AUTO RE-ARM TIME (OPTION 20)	49
8.5.15	RELAY PROGRAMMING	50
8.5.16	GROUP MODE (OPTION 26).	52
8.5.17	INPUT FUNCTION AND TRIGGER	53
9	SPECIFICATIONS	54
9.1	Z25 SPECIFICATION	54
10	Z-SERIES KEYPADS	56
10.1	PTE0210 LCD KEYPAD	56
10.2	PTE0230 TOUCH KEYPAD	57
10.3	LCD KEYPAD OPERATION.	58
10.3.1	WIRING UP YOUR Z-SERIES LCD KEYPAD	58
10.3.2	KEYPAD STATUS LEDs	58
10.3.3	ARMING/DISARMING THE FENCE USING THE KEYPAD	59
10.3.4	MENUS	59
10.3.5	KEYPAD STATUS DISPLAY.	60
10.3.6	CHANGING THE KEYPAD MESSAGES AND ADDRESS .	60
10.4	TO EXIT KEYPAD PROGRAMMING	62
10.5	CONNECTING MULTIPLE KEYPADS TO A SYSTEM . .	62
10.6	NOTES REGARDING KEYPAD CONFIGURATION . . .	63
10.7	CALIBRATING THE VOLTAGE DISPLAY	64
10.8	USING THE PTE0230 TOUCH KEYPAD	66
10.8.1	SCREENS	66
10.8.2	HOME SCREEN	66
10.8.3	ALARM SCREEN	68
10.8.4	SETTINGS SCREEN	69
10.8.5	EVENTS SCREEN	72
10.8.6	ZONES AND ZONE DETAILS SCREEN	73
10.8.7	PROGRAM DEVICES SCREEN.	74
11	REMOTE CONTROL UNIT	76
11.1	FEATURES	77
11.2	INSTALLATION.	77
11.3	OPERATION AND CONFIGURATION	78

12	STANDARD REQUIREMENTS FOR SECURITY ELECTRIC FENCES	79
12.1	DEFINITIONS	79
12.2	GENERAL REQUIREMENTS FOR ELECTRIC FENCES . .	79
12.3	PARTICULAR REQUIREMENTS FOR ELECTRIC ANIMAL FENCES IN AUSTRALIA	81
12.4	INSTALLATION OF ELECTRIC SECURITY FENCES . . .	82
12.4.1	GENERAL	82
12.4.2	LOCATION OF ELECTRIC SECURITY FENCE	82
12.4.3	PROHIBITED ZONE FOR PULSED CONDUCTORS . . .	83
12.4.4	SEPARATION BETWEEN ELECTRIC FENCE AND PHYSICAL BARRIER	85
12.4.5	PROHIBITED MOUNTING.	86
12.4.6	OPERATION OF ELECTRIC SECURITY FENCE.	86
13	APPENDIX A: GROUP SIMULTANEOUS PULSE FEATURE	88
13.1	GROUP SIMULTANEOUS PULSE FEATURE	88
13.2	GROUP MODE PROGRAMMING (OPTION 26)	88
13.3	GROUP LINKING VIA THE KEYPAD “BUS”	89

1 QUICK START GUIDE

1.1 CHANGING THE PROGRAMMING OPTIONS

Default Installer PIN	012345
Default User PIN	1234

First you have to enter Programming mode.

Command	Key1	Key2	Key3	Key4	Key5	Key6	Key7	Key8	Key9
Enter Programming Mode	Installer Pin								
							*	0	#

When you have entered Programming mode you can begin to enter the following options to configure your Z25 Security Energiser. Default Values are highlighted in grey.

Command	Key1	Key2	Keys 3 and 4		Key5
Change the Installer PIN 6 Digits	0	0	Enter the new 6 digit Installer PIN		#
High Power Mode Power Level	0	1	Enter the value in Hundreds of Volts		#
			Example: to set 8.2kV, use 82 for keys 3 and 4. Default is 85 (8.5kV)		
Low Power Mode Power Level	0	2	Enter the value in Hundreds of Volts		#
			Example: to set 1.3kV, use 13 for keys 3 and 4. Default is 11 (1.1kV)		

Command	Key1	Key2	Keys 3 and 4										Key5
Return 1 Fence Alarm Voltage For High Power Mode	0	3	Enter the value in Hundreds of Volts										#
			Example: to set 3.8kV, use 38 for keys 3 and 4. Default is 40 (4.0kV)										
Return 2 Fence Alarm Voltage For High Power Mode	0	4	Enter the value in Hundreds of Volts										#
			Example: to set 3.8kV, use 38 for keys 3 and 4. Default is 40 (4.0kV)										
Return Fence Alarm Voltage For Low Power Mode	0	5	Enter the value in Hundreds of Volts										#
			Example: to set 0.8kV, use 08 for keys 3 and 4. Default is 05 0.5kV)										
Bad/Missed Pulse Count Before Alarm Triggers	0	6	Enter the number of Missed Pulses										#
			Example: to set 14 counts, use 14 for keys 3 and 4. Default is 03										
Battery Alarm Voltage (Volts). Alarm Value Shown, Reduced Power is 1V less	0	7	00	01	02	03	04	05	06	07	08	09	#
			9.0	9.5	10.0	10.5	11.0	11.5	12.0	12.5	13.0	13.5	
Siren On Time (S=Seconds, M=Minutes)	0	8	00	01	02	03	04	05	06	07	08	09	#
			10S	30S	1M	2M	3M	4M	5M	20M	45M	130M	

Quick Start Guide

Command	Key1	Key2	Keys 3 and 4										Key5
			00	01	02	03	04	05	06	07	08	09	
Siren Off Time (S=Seconds, M=Minutes)	0	9	10S	1M	2M	5M	10M	20M	30M	40M	50M	60M	#
Siren Cycles	1	0	00	01	02	03	04	05	06	07	08	09	#
			0	1	2	3	4	5	6	7	8	9	
Gate Entry/Exit Delay (S=Seconds, M=Minutes)	1	3	00	01	02	03	04	05	06	07	08	09	#
			05	30S	1M	2M	3M	4M	5M	6M	7M	8M	
Chime Mode	1	4	01		02		03		04		05		#
				None	Door Chime		Siren		Fence Alarm		Gate Beeps Plus Siren		
Combined Options 1 (Add up the options you want. E.g. for Max Power and Lim- it output: 2 + 4 = 6 Therefore enter 06 for keys 3 and 4	1	6	+2		+4		+8		+16		+32		#
			Maximum Power at all times	Limits output to 2.5J per Zone	Enables IR Tamper.	Stop slaves on comms fail	Stop Energiser sending alarm memory						
Anti Bridging Threshold	1	7	Enter in the percentage difference required to trigger the Anti-Bridging alarm. Default is 00 (Disabled)										#

Command	Key1	Key2	Keys 3 and 4								Key5		
			+1	+2	+4	+8							
Combined Options 2 (Like Combined Options 1)	1	8	+1	+2	+4	+8					#		
			Siren Chirp on Arm	Enable Entry Exit Gate	4800 Baud	9600 Baud							
Auto Re-arm Time S=Seconds, M = Min, D=Disabled	2	0	00	01	02	03	04	05	06	07	08	09	#
			0S	30S	1M	2M	3M	4M	5M	6M	7M	D	
Relay 1	2	1	Explained under "1.1.1.1 Relay Functions" Default is 09 (Strobe 1)									#	
Relay 2	2	2	Explained under "1.1.1.1 Relay Functions" Default is 13 (Strobe 2)									#	
Relay 3	2	3	Explained under "1.1.1.1 Relay Functions" Default is 08 (Siren)									#	
Group Mode	2	6	00	01	02	Etc	15					#	
			No Group	Master	Slave 1			Slave 14					
Input 1	2	7	Options Explained under "" Default is 00 (N/O Arm/Disarm)									#	
Input 2	2	8	Options Explained under "" Default is 16 (N/C Gate 1)									#	
Input 3	2	9	Options Explained under "" Default is 17 (N/C Gate 2)									#	
Exit Programming Mode	*	#											

Quick Start Guide

1.1.1 Relay Functions

The table below is for use for the relay programming options mentioned in the table on the previous page.

Keys 3 and 4	Function	Description
00	Fence 1	Triggers when Zone 1 is Armed and Return Voltage is below the Threshold Voltage
01	Fence 1 or Off	Triggers when Zone 1 is Disarmed or Return Voltage is below the Threshold Voltage
02	Armed 1	Zone 1 is Armed
03	Fence 2	Triggers when Zone 2 is Armed and Return Voltage is below the Threshold Voltage
04	Fence 2 or Off	Triggers when Zone 2 is Disarmed or Return Voltage is below the Threshold Voltage
05	Armed 2	Zone 2 is Armed
07	General	Triggers on AC Fail, Tamper, Low Battery/Bad Battery, Gate Alarm or Internal error. Latched (internal errors only)
08	Siren	Triggers on Fence Alarm, Gate or Tamper. Will time out after the Siren Time Out time. Latched
09	Strobe	Triggers on Fence alarm, Gate or Tamper. Only turns off on Energiser Disarm. Latched
10	AC Fail	Triggers on AC Fail
11	Low/Bad Battery	Triggers on Low or Bad Battery
12	Tamper	Triggers when the Tamper Input (if configured) is triggered
14	Gate 1 or 2	Triggers on a Gate Alarm

Keys 3 and 4	Function	Description
15	Siren Caused by Gate	Behaves like siren, only for Gate Alarms
16	Armed - Low Power Mode	Triggers when Armed in Low Power mode
17	Group Armed	Triggers when group is Armed. Only configurable on group master.
18	Group general	Triggers on group general Alarm. Only configurable on group master.
20	Host Control	This Relay is completely controlled from a Host system such as Perimeter Patrol or a Keypad. If the Host system is disconnected from the Energiser for more than 30 seconds, the Relay will automatically change to the Alarm State
21	Host Control - Not Fail Safe	This Relay is completely controlled from a Host system such as Perimeter Patrol or a Keypad. If the Host system is disconnected then the Relay will maintain its current state until the Host re-connects and requests the relay to change state.

Quick Start Guide

Key3	Input Trigger	Key4	Input Function
0	Normally Open (Active when Closed)	0	Arm All Zones when Active / Disarm otherwise
1	Normally Closed (Active when Open)	1	Arm Zone 1 when Active / Disarm otherwise
2	Momentary Toggle (Toggle between states)	2	Arm Zone 2 when Active / Disarm otherwise
3	NO Pulse Extend (Extend a short Close signal by 3 seconds)	3	Low Power when Active / High Power otherwise. Requires Energiser to be Armed
4	NC Pulse Extend (Extend a short Open signal by 3 seconds)	4	Low Power Zone 1 when Active / High Power otherwise. Requires Energiser to be Armed
		5	Low Power Zone 2 when Active / High Power otherwise. Requires Energiser to be Armed
		6	Gate 1 is Open when Active / Closed otherwise
		7	Gate 2 is Open when Active / Closed otherwise
		8	Tamper Alarm triggered when Active
		9	Pass Through input signal to other device

1.2 SUMMARY OF KEYPAD FUNCTIONS

Command	Key1	Key2	Key3	Key4	Key5	Key6	Key7	Key8	Key9	Key10
Arm/Disarm		USER PIN			#					
Silence the Energiser Siren	1	4	7	0	#					
Enter Programming Mode		INSTALLER PIN					*	0	#	
Enter Keypad Programming Mode		INSTALLER PIN					*	0	1	#
Exit Programming (Any Mode)	*	#								
Change a User PIN, 4 Digits		USER PIN			*	0	#	[New PIN]	#	
Arm All Zones (Multi-Zone Groups)		USER PIN			*	1	0	#		
Arm Specific Zone (up to Zone 15)		USER PIN			*	1	Zone Number		#	
Disarm All Zones		USER PIN			*	2	0	#		
Disarm Specific Zone (up to Zone 15)		USER PIN			*	2	Zone Number		#	
Switch to Low Power Mode (All Zones)		USER PIN			*	4	1	#		
Switch Specific Zone to Low Power		USER PIN			*	4	1	Zone Number		#
Switch to High Power Mode (All Zones)		USER PIN			*	4	2	#		
Switch Specific Zone to High Power		USER PIN			*	4	2	Zone Number		#
Arm Gate Zone only		USER PIN			*	4	#			
Bypass Siren (All Zones)		USER PIN			*	5	2	#		
Bypass Specific Zone Siren		USER PIN			*	5	2	Zone Number		#

Quick Start Guide

Command	Key1	Key2	Key3	Key4	Key5	Key6	Key7	Key8	Key9	Key10
Re-enable Siren		USER PIN			*	5	1	#		
Re-enable Specific Zone Siren		USER PIN			*	5	1	Zone Number		#
Bypass Gate Alarm (All Zones)		USER PIN			*	5	4	#		
Bypass Specific Gate Alarm		USER PIN			*	5	4	Zone Number		#
Re-enable Gate Alarm (All Zones)		USER PIN			*	5	3	#		
Re-enable Specific Gate Alarm		USER PIN			*	5	3	Zone Number		#
Arm in Agricultural Mode (No Alarms)		USER PIN			*	9	Zone Number			
Reset and Display Firmware Version		USER PIN			*	6	8	#		
Reset and Return to Factory Defaults		INSTALLER PIN					*	6	8	#

Energiser Function	Key1	Key2	Key3	Key4
Clear Alarm Memory	*	1	#	
Display the Group ID of the Energiser	*	2	6	#
Siren Test	*	6	3	#
Battery Test	*	6	4	#
Display the Stored Joules (while Armed)	*	6	7	#
Power Boost	*	9	9	#
Panic (Trigger the Siren and Disarm the Energiser)	Press the Panic Key for 3 seconds continuously			

Keypad Specific Function	Key1	Key2	Key3	Key4
Re-analyse the Energiser Group	*	6	8	#
Keypress Beep On/Off	*	5	1	#
Chimes On/Off	*	5	3	#
Error Tones On/Off	*	5	4	#
Keypad Alarm Tones On/Off	*	5	5	#
Change Backlight Mode	*	8	#	
Display Keypad Model	*	9	#	

1.3 JUMPERS

Jumpers quickly allow you to turn on and off different features, or reset the device to defaults. For more information on how to use the configuration jumpers and what each one does refer to “7.3 Jumpers” on page 38.

JUMPER	FUNCTION
J3	Inhibit AC fail error.
J4	Factory default jumper Off to return programmable options to factory defaults on power up.

Jumpers are located in the middle of the board above the Keypad Connector

1.4 QUICK TEST OF CONFIGURED UNIT

Now that the Z25 is configured to your fences requirements, it is a good idea to test the configuration before connecting the Z-Series energiser to a fence. The reason for this is that you could get spurious results if you test on the final fence and you will never be certain whether the issue lies with the fence, the Z-Series energiser, or the configuration of the unit itself.

To test your unit it is best to connect your Z25 with a test fence, this is done by connecting the cables as shown in the picture below.

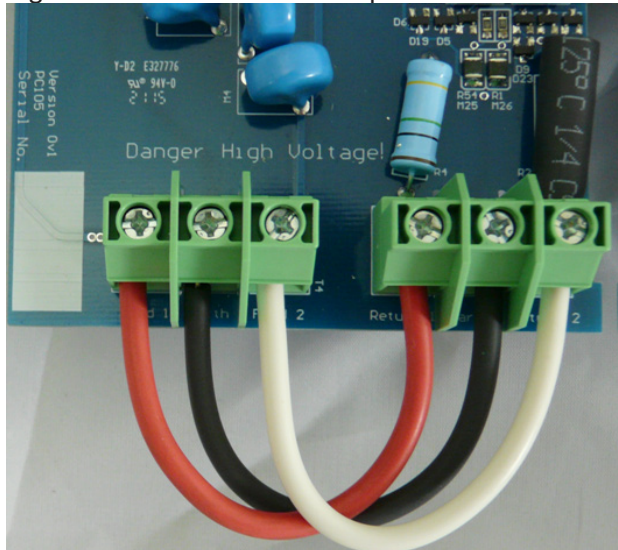

Power the Z25 and then Arm it. The unit should begin pulsing and not show any alarms. Disarm the Z25 and remove the fence cable as shown in the picture below.

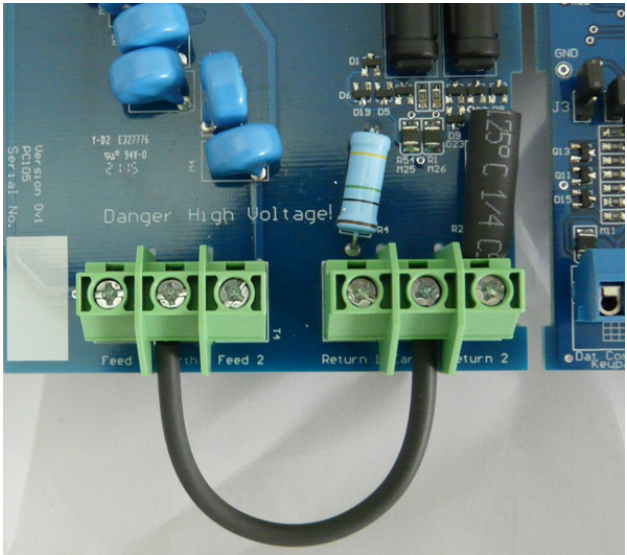

Arm the Z25 once again, after 3 pulses (unless you configured it otherwise) the unit should go into alarm as the fence will appear to be cut. Check that any sirens, strobes or relays correctly activate as you expect.

If your site consists of multiple Z-Series test each energiser one at a time as shown in the above photographs. Following that each energiser should be assigned a unique group ID with only one Z-Series device as the master unit (For more information see “13 Appendix A: Group Simultaneous Pulse Feature” on page 88). After that each Z-Series device can be connected together via the keypad bus and tested using group Arm and Disarm commands, they should all pulse in unison when armed.



By disconnecting each Z-Series Energiser in turn from the keypad bus (shown in the above diagram) you can check to see how each Z-Series device behaves under communications failure (comms fail) conditions. This way, you can test to see that the relays have been configured correctly for comms fail. Once you are satisfied that each Z-Series device is configured correctly you can begin to wire them to the real fence.

1.5 CONNECTING YOUR Z25 TO THE FENCE

This is covered under “5.3 Example of Fence Wiring” on page 32. In depth installation instructions begin on page 30. After the Z25 has been wired up you can begin to protect your perimeter.

2 INTRODUCTION

Thank you for purchasing a JVA security electric fence energiser. The growing use of non-lethal electric security fences around the world is indicative of the confidence security professionals are placing in this form of perimeter security. The reason for this popularity is simple – monitored electric security fences are effective and they reduce false alarms when compared to other technologies.

DEMARICATION	The JVA electric fence around your property shows you mean business.
DEFLECTION	Intruders are deflected to softer targets.
DETERRENCE	The safe, powerful JVA shock is a strong deterrent to intruders.
DELAY	The barrier will help delay an intruder, giving you more time to react.
DETECTION	The JVA's voltage monitor warns you of any tampering with the fence.
DEPENDABLE	60 seconds a minute, 60 minutes an hour, 24 hours a day, 365 days a year, your JVA electric security fence is monitored by an alert, sober, electronic watchman.

Once every second the JVA Z25 energiser produces a very short-duration, safe, high-voltage pulse and sends it down the fence live wires. The JVA Z25 then monitors the voltage at the end of this live wire, checking that the voltage is being maintained along the entire fence line. In the event of a voltage drop caused by shorting, cutting or poor fence maintenance, the monitor will trigger an alarm, alerting you to the problem.

Designed and manufactured to meet the most stringent international safety standards, the JVA Z25 is in a class of its own when it comes to features and benefits at an affordable price.



Feature	Benefits
Australian designed and manufactured	High reliability and great service
Programmable Options	Customise the energiser to unique fence conditions
Wall-mountable, robust enclosure with easily detachable PCB chassis	Ease of installation and repair
In built LCD voltage display and status lights	See fence conditions at a glance
Internal 7aH 12V rechargeable battery	Ensure continued operation of your security electric fence in the event of a mains power failure
Optional LCD Keypad	Ease of control and display of fence voltages
Optional PC and internet connections	Integration with security information management systems
Low Power mode	Detection together with reduced voltage for during the day
Switched +12V outputs for Siren and Strobe	Local audible and visual indication alerting user to breach of security
Earth monitor input	Ensures that all the wires on the fence are monitored continually
Enclosed fence terminals	Tamper resistant and prevents accidental contact with high voltage

3.1 MORE FEATURES

- Meets Safety and EMC standards (reports available on request)
- 2 joules peak output energy
- High and low Power mode
- Built in charger and space for a 12V 7.2aH backup battery
- Alarms on fence short or open circuit
- Control and programming via a Z-Series keypad
- Monitor via PC (using Perimeter Patrol software)
- Internal beeper
- AC fail, low battery and bad battery detection
- Large number of keypad programmable options
- Adjustable fence voltage level
- Three 12V dc switch outputs (also referred to as relays)
- Three control Inputs configured as NO or NC contacts

4

DESCRIPTION

4.1

JVA Z25 - EXTERIOR



4.2 FRONT PANEL STATUS LIGHTS

Status Light	Description
POWER	On whenever the unit has power
ARMED	On when the unit is armed (pulsing), will flash when in Low Power mode
FENCE	Green when voltage on and OK, Red when there is a fence alarm
GATE	On when there is a gate alarm
STATUS/FAULT	The number of times the status/fault light flashes indicates any faults on the energiser. See the table in section “7.2 Status Codes” on page 38

4.3 FRONT PANEL LCD DISPLAY

The display on the JVA Z25 shows the voltage at the fence and return terminals. The left is the return and the right is the return voltage for zone 1 and zone 2 respectively.

The LCD also shows the programming option and current setting when in programming mode. This allows the programming options settings to be checked easily.

4.4 INPUTS AND OUTPUTS

See “7 Technical Information” on page 36.

4.5 KEYPAD (OPTIONAL)

A Z-Series keypad can be used to remotely monitor and control the Z25. It is also used to set the programmable options. See “8 Programming Options” on page 40

4.6 Z-SERIES MODELS

- Z11 Single zone, conventional 1.5 Joule.
- Z13 Single zone, conventional 2.8 Joule.
- Z14 Single zone, conventional or Bi-Polar 4 Joule.
- Z14R Z14 with relays and IR Tamper circuit.
- Z14E Z14R for high value animals. When the Z14E detects a ground short it switches to low power mode until the short is removed. If an animal is caught in the fence, causing the short, it will be in less distress than with a conventional security energiser.
- Z18 Single zone, conventional or Bi-Polar 8 Joule, contains relays and IR Tamper circuit.
- Z25 Dual zone, conventional 5 Joule (2.5 Joules per zone).
- Z28 Dual zone, conventional 8 Joule (4 Joules per zone).
- ZM1 Single zone start of fence monitor with Distant Fault Detection™
- ZM20 Twenty sector loop monitor.
- ZLM4 Four zone low voltage electric fence monitor.



4.7 Z-SERIES LCD KEYPAD (OPTIONAL)

The Z-Series LCD keypad allows for easy remote control of your JVA energiser. Arming and disarming, responding to alarms or just checking the fence

voltage, the LCD keypad makes this easy through a simple menu system or key sequences (shortcuts). Your security is protected by a user PIN.

A keypad is also required to change the programmable options, see “8 Programming Options” on page 40.

For information on how to control the Z25 via the keypad, see “10.3.3 Arming/Disarming the Fence Using the Keypad” on page 59.

4.8 INTERNAL BEEPER/KEYPAD BEEPER

Depending on the chime setting, the internal beeper and keypad beeper will sound when there is a fence alarm, a gate alarm, a door chime or a general alarm. Should the battery voltage run low, the keypad will beep 4 times before the energiser automatically enters Low Power mode to preserve the battery.

4.9 PROGRAMMABLE OPTIONS

The Z25 has many programmable options. To alter these options, a Z-Series keypad must be used. The options are explained in “8.5 Programming Options in Detail” on page 41. Each parameter has a factory set default.

4.10 ARM INPUT AND KEY SWITCH

The JVA Z-Series energiser can be armed (to energise the fence) by closing a contact wired into the arm input. On some models a key switch is fitted to the right-hand side of the case for this purpose.

An external switch device, for example a remote receiver or access control keypad, can also be wired into the energiser to arm and disarm the unit.

4.11 GATE INPUT

An input can be configured for a Gate Function and wired to a gate switch to trigger an alarm when a gate is opened. Alternatively, it may be programmed to many other functions. For more information see “8.5.17 Input Function and Trigger” on page 53.

4.12 LOW POWER MODE

Z25 energisers can be switched into Low Power mode. Low Power mode may be used in situations where the fence is not required to be a deterrent but is still required to actively detect intrusion. In Low Power mode the fence live wires operate at a much lower voltage, typically 500V peak. See Section “10.3.3 Arming/Disarming the Fence Using the Keypad” on page

59 for details on using the keypad to set Low Power mode.

4.13 AGRICULTURAL MODE

The Z-Series Energiser can be armed in Agricultural Mode to provide a way test the fence without triggering any of the alarms. This mode should only be used to confirm that a new installation is operating correctly. The Energiser will remain in this mode until the Energiser is Disarmed.

The Fence Alarm LED will flash to indicate the return voltage is below the threshold, however it will not trigger the alarm.

4.14 GROUP SIMULTANEOUS PULSE FEATURE

In some installations it may be preferable to provide the ability to link multiple units into a group. When linked, the individual Z-Series devices become a group. As many as fifteen energisers can be grouped. Individual units in a group have simultaneous high voltage output pulses and act as if they are one energiser with multiple outputs. This is designed so that no possible combination of individual outputs can be dangerous. For more information see “13 Appendix A: Group Simultaneous Pulse Feature” on page 88

4.15 REMOTE CONTROL UNIT (OPTIONAL)

The Remote Control Unit provides the Z25 with the ability to arm or disarm the energiser via a compact key chain fob remote control. If using the remote control the siren can be used to acknowledge arming with 1 beep and disarm with 2 beeps, see programming option “8.5.10 Chime Mode (Option 14)” on page 46.

The remote controls have a range of up to 100 metres. They come fitted with a LR27A 12V battery that will provide up to 2 years service.

4.16 CABLING

High voltage cabling (fence feed and returns) should be run using suitably rated cable. Double insulated electric fence “underground” cable is suitable. High voltage cables must never be run within the same conduit as low voltage cables. A minimum distance of 30mm should be kept between high voltage and low voltages cables.

To maintain the IPx4 rating of the enclosure and to ensure moisture does not enter the enclosure via the cable entry area a silicon sealant (neutral cure) must be used to seal all the cable passages.

4.17 LIGHTNING PROTECTION

Although the Z25 contains internal lightning protection elements, external lightning protection elements such as additional external lightning protection kits are recommended to further reduce lightning damage and thus reduce repair costs. They are available from your local dealer.

4.18 EARTH LOOP MONITORING

The Z25 has two fence earth terminals. If the earth monitoring facility is not required, the Earth Out and Earth Return terminals must be joined with a wire bridge. Directions on how to wire for earth loop monitoring are in Section “5.3 Example of Fence Wiring” on page 32.

4.19 NOISE AND INTERFERENCE

The Z25 contains a microprocessor. Extreme electrical noise can upset microprocessors. The most likely cause of such noise is the high voltage output from the unit itself. In the event of erratic behaviour, check that the high voltage wiring is firmly connected to the terminals and that no sparking is seen. The Z25 is designed to self-recover from interference. Powering off (both AC and battery) should not be necessary.

4.20 PC CONTROL

A standard Windows PC may be used to control and monitor a group of Z-Series devices. Ask your JVA distributor for a demonstration of Perimeter Patrol™ software. Z-Series devices can be connected to a PC using either a serial data adaptor, such as the PAE223 or TCP/IP using a PAE212.

5 **INSTALLATION**

JVA recommends installation by qualified technicians.

5.1 **INSTALLATION STEPS**

1. Read the entire manual first!
2. Design and build the fence. (Beyond the scope of this manual.) Ask your distributor for help if required.
3. Decide where the JVA Z25 is to be mounted. If on an external wall it should be housed within a waterproof equipment box and definitely not in direct sunlight.
4. Remove the JVA Z25 PCB chassis from the housing by removing the 2 screws.
5. Mount the housing by using 4 screws through the rear of the box.
6. Replace the PCB chassis.
7. If using a keypad, remove the rear housing of the keypad and fix it to the wall.
8. Wire the low voltage cables to the PCB terminals*.
9. Wire the high voltage cable to the PCB terminals*.
10. If earth monitoring is not going to be used on the fence, connect a bridge wire from earth out to earth return.
11. Ensure that the key switch is off.
12. Fit the battery leads to the battery. The status light should blink twice repetitively to show mains fail, unless J3 is fitted.
13. Mount the 230 – 18V transformer and connect the 18V side to the Z25 16V input terminals. (AC is not polarity sensitive.)
14. Do not connect a live or neutral to the earth terminal.
15. Replace the front cover.
16. Turn AC power on.
17. Arm and disarm the energiser via the keyswitch or keypad, if fitted. The status light should stop blinking.
18. Arm the unit.
19. Check to ensure that a short anywhere on the fence triggers the alarm.

Ensure that the user understands how to change the User PIN and is in possession of this Installer/User Manual and the installer's contact details.

* NOTE: Keep high voltage and low voltage cables at least 30mm apart. Do not run high and low voltage cables in the same conduit.

5.2 INTERIOR CONFIGURATION

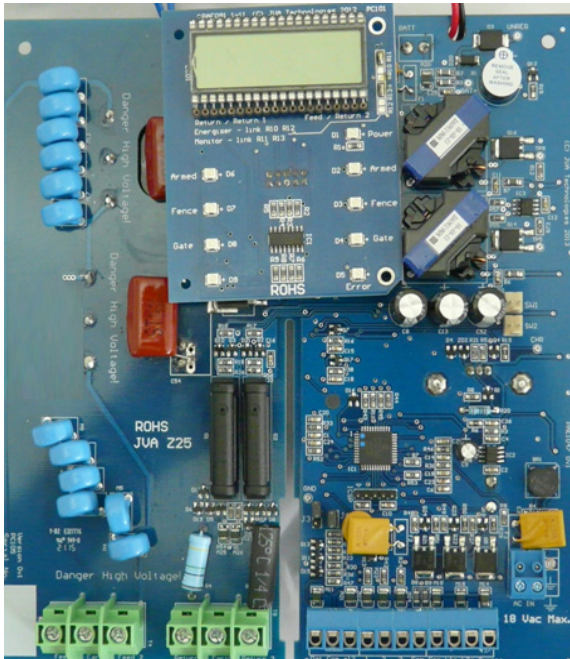

Installation

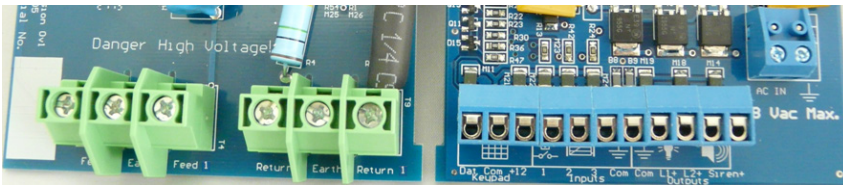

High Voltage Terminals

Low Voltage Terminals

5.3 EXAMPLE OF FENCE WIRING

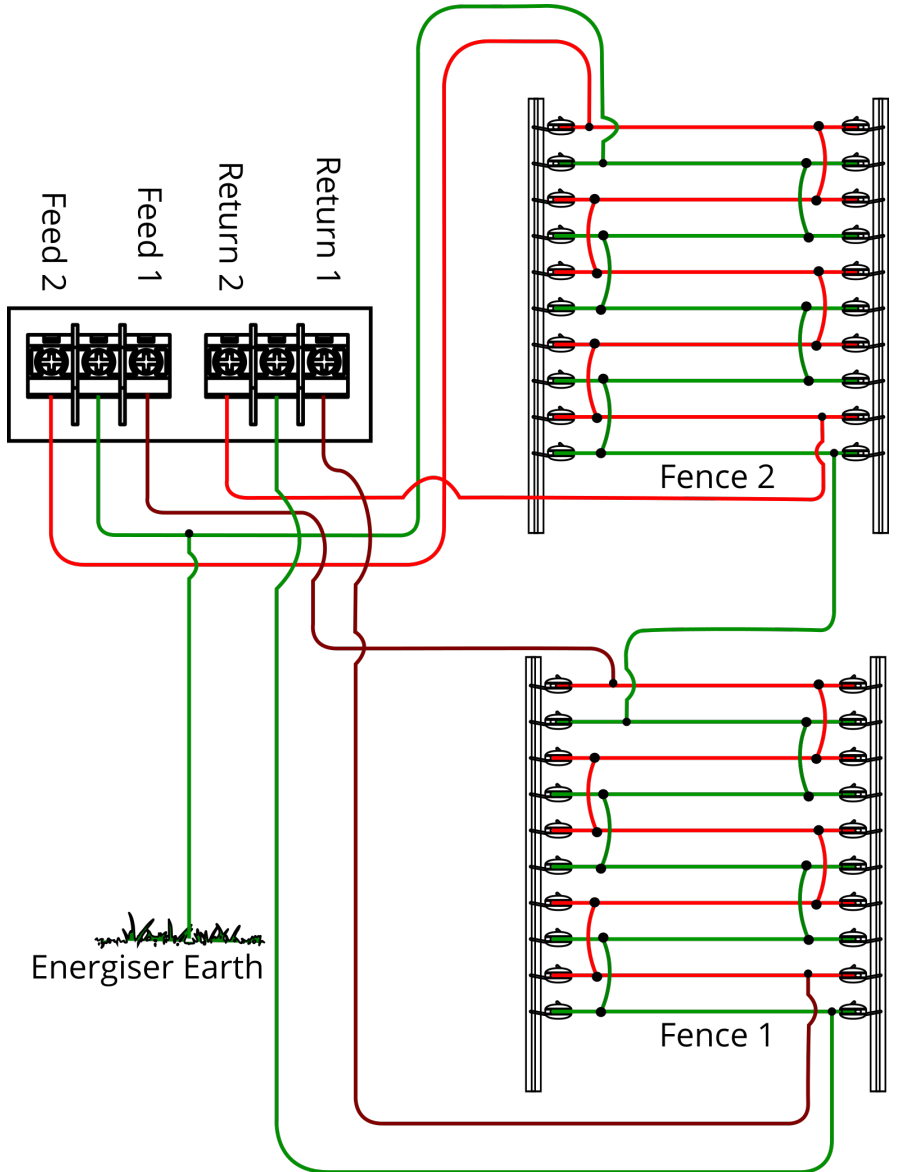

Z25 energiser configured for conventional fence operation

6 CONTROL

Your JVA Z25 security energiser has been designed for ease of operation. It may be armed and disarmed using any of the following:

- Key switch or remote switch connected to the control input (IN1)
- Remote control radio receiver connected to IN1
- JVA permanent magnet key fob
- Z-Series Keypad (LCD or Touch)
- JVA GSM module *not all versions
- Windows PC running JVA Perimeter Patrol
- Low level interface (wired to control inputs and relay outputs) from a third party security alarm panel or Physical Security Information System (PSIM)

NOTE: More than one method may be used in the one installation.

6.1 MAGNETIC PROXIMITY SWITCH

The Z25 may be controlled using the JVA permanent magnet key ring fob. To operate, the fob must be held against the control zone marked on the front label. The energiser will beep and toggle from armed to disarmed or vice versa after the fob is swiped slowly over the sensitive area. In order to enable use of the magnetic proximity switch, Option 11 must be set to 2. The magnetic proximity receiver should be disabled in the programmable options if it is not being used (set Option 11 to 0).

6.2 ARMING THE FENCE USING THE KEYPAD.

Enter your **User PIN #** (Default User PIN is 1234).

Make sure the red ARM light comes on.

- The keypad will beep twice to confirm that the system is armed.
- The fence will power up and if all is well (no faults) the system will be ready to deter and detect.
- If there is a fault on the fence and it cannot achieve full voltage, the LCD screen will indicate that there is a fault.
- To disarm the system, enter your User PIN and press #.

6.3 ACTIVATING LOW POWER MODE

To switch to Low Power mode, enter your **User PIN *41#**. In Low Power mode the fence will still be powered and any breach will be detected, but the voltage will be much lower than normal operation. The ARM light will flash in Low Power mode.

Enter your User PIN and press ***42#** to switch back to Full Power mode.

Alternatively, the unit can be switched to Low Power mode using a switch connected to a control input, if it has been programmed accordingly. See “8.5.17 Input Function and Trigger” on page 53

The Keypad can be used to switch individual zones into Low Power Mode. See “1.2 Summary of Keypad Functions” on page 13

NOTE: Switching Power Mode will not automatically Arm the Energiser

6.4 WHEN AN ALARM OCCURS

If the system is armed and the fence is tampered with, the fence light will flash and then remain on. A siren or strobe connected to the unit will turn on. If the energiser is connected to an alarm system for monitoring, an alarm signal will be sent to the alarm company monitoring the alarm system.

An alarm will also sound if the gate input is opened and the entry/exit delay time has elapsed.

6.5 TO SILENCE THE ALARM

Enter **1470#** on the Keypad. This will silence the Siren but not disarm the system; the armed light will remain on and the Strobe will still indicate the Zone that was in Alarm.

Entering this command will force the Siren into its “Siren Off Time”. If the fault remains on the Fence, then the Siren will sound again after the “Siren Off Time” has elapsed. If however, the fault is cleared, then the Siren will be ready to sound again for the next Alarm.

Alternatively, disarming the energiser will silence the alarm.

6.6 CHANGING THE USER PIN

- Enter the current **User PIN** (default is 1234) and press ***0#**. This enters User Programming mode.
- Enter your new **User PIN** (must be 4 digits) and then **#**.
- Press ***#** to exit User Programming mode.
- Make sure your new User PIN works by using it to arm the energiser.

6.7 STANDBY BATTERY

Should there be a loss of mains power, the power light on the keypad will go off. If the loss of power is prolonged, the battery may discharge power and become ineffective. The power light will start to flash indicating a battery low power problem. If the battery is fully depleted, the unit will not pulse.

If the standby battery requires replacement, the power light will flash and the status light will flash three times.

6.8 STATUS LIGHT

The energiser status light indicates that the energiser requires attention. See Section “7.2 Status Codes” on page 38.

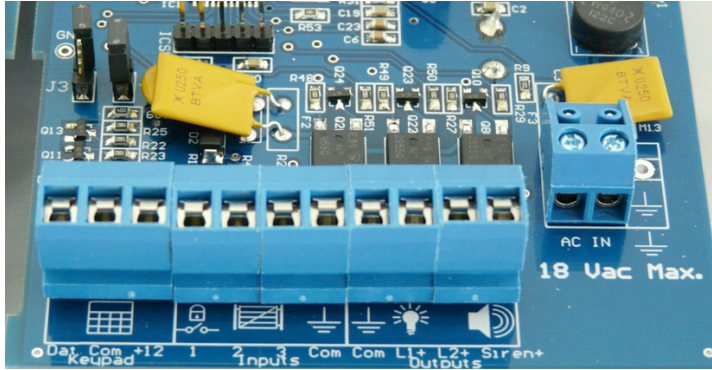

Label	Type	Description
KEYPAD	3 Way	Supplies power and data line for an external keypad. The +12 source on these terminals is protected with 1A self resetting fuse.
INPUT 1	1 Pin with common Ground	Energiser control input 1 (dry contact momentary) internally wired in parallel with the key switch. Can be used for a remote switch or a radio receiver. The receiver may be powered from the keypad +12V terminal.
INPUT 2	1 Pin with common Ground	Energiser control input 2 (dry contact). Default function is gate 1 input, normally closed.
INPUT 3	1 Pin with common Ground	Energiser control input 3 (dry contact). Default function is gate 2 input, normally closed.
Output L1+	1 Pin with common Ground	Switched 12V output. Default function is Zone 1 Strobe. 30W max, shared between 3 outputs. A buffer relay should be used when connecting these outputs to an alarm panel. High side switched

Label	Type	Description
Output L2+	1 Pin with common Ground	Switched 12V output. Default function is Zone 2 Strobe. (Same output requirements as L1+)
Output Siren+	1 Pin with common Ground	Switched 12V output. Default function is Energiser Siren. (Same output requirements as L1+)
18Vac	3 Way	18Vac 1.5A power input plus earth. Connection of the earth is only required where local safety or wiring codes demand it. This should be connected to the cabinet or mains earth NOT the fence earth.
Batt	B a t t e r y leads	12V dc or battery connection via F1 (3 Amp resettable fuse).

7.1 POWER OPTIONS

The Z25 has 2 sources of power, 18Vac and 12Vdc (battery). If using solar power and an external battery, connect the battery to the battery leads, not the 18Vac input.

A 24Vdc 1.5A supply can be used in place of the 18Vac supply. The correct connection is +24V to the left AC pin, GND to the mid AC pin. Due to the stored energy in a 24Vdc plug-pack, an AC fail may take up to 5 minutes to be reported.

NOTE: Use only rechargeable batteries.

7.2 STATUS CODES

Status LED Number of Flashes	Interpretation	Corrective Action
1	Tamper detected	Fix the tamper
2	Mains supply fail	Restore mains power
3	Low battery, bad battery	Charge or replace battery
4	PCB service fault	Seek advice from your installer or distributor

If a minor error occurs, it will self-clear if the error condition is removed. If the mains fail or the battery runs low, it will not disarm the energiser. However, without mains power, the battery will eventually be depleted and the energiser will attempt to maintain operation by entering Low Power mode after 4 warning beeps. If the battery charge continues to fall, the energiser will eventually stop. Once mains power has been restored and the battery has recovered, the energiser will rearm itself automatically after 4 warning beeps. A PCB fault will disarm the energiser. If an error disarms the energiser, the fence alarm will be activated.

If an error has momentarily caused the energiser to stop pulsing, this can be corrected by disarming and rearming the unit. Should the error recur return the unit for service.

7.3 JUMPERS

Jumper	Function	Purpose
J3	Inhibit Mains fail error	J3 is fitted to inhibit Mains fail errors if the intention is to operate the energiser on DC only (as in solar power systems).

Jumper	Function	Purpose
J4	<p>Factory default jumper</p> <p>Off to return programmable options to factory defaults on power up.</p>	<p>If the energiser needs to be defaulted to factory settings, remove all power (AC and battery) and remove the J4 jumper. Reapply the mains and the battery power. Reapply the J4 jumper and the Energiser will be reset to default settings.</p>

How to fit a Jumper/Bridge/Shunt

A fitted Jumper is shown as closed in the diagram below. If a jumper is not to be fitted it can be placed over a single pin, this is shown as open in the diagram below.

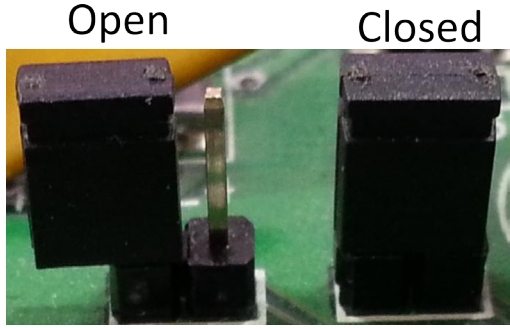

8 PROGRAMMING OPTIONS

The Z25 has permanent memory in which the programming options are stored. These are factory pre-set but can be field programmed using a Z-Series keypad. To see the programming options in brief see “1.1 Changing the Programming Options” on page 6

8.1 PROGRAMMING MODE

To enter Programming mode, enter the 6-digit Installer PIN (default is 012345) followed by *, 0, # keys. The keypad will beep twice to indicate that the command was accepted. If the Installer PIN was incorrect, the keypad will beep 3 times. Pressing the # key will cycle through all the options on the LCD.

NOTE: Not all option numbers are used.

8.2 TO EXIT PROGRAMMING MODE

After programming, press *, # to exit. If left unattended, the unit will time out and auto exit Programming mode after approximately 5 minutes.

8.3 CHANGING THE INSTALLER PIN

The installer PIN may only be changed while in Programming mode.

To enter a new installer pin, press **00** followed by the new 6-digit Installer PIN, then the # key.

If you cannot remember your Installer or User PIN, return the unit’s memory to default. To do this, remove power (AC off and disconnect the battery), open the energiser, remove jumper J4 and reconnect the battery for about 10 seconds. Re-fit J4.

This will return all options to the factory set defaults.

8.4 CHANGING AN OPTION

Most of the options have possible values in the range of 0 to 9.

To change any options, the unit must be in Programming mode. Check the option number (see table below) and then the table of values for that option. Then press the option number followed by the required value. When the programming is completed, exit from Programming mode. (See above)

For example, to change the power level to maximum, enter programming mode and press 0199#, and the keypad will beep twice to indicate that the

command was successful.

8.5 PROGRAMMING OPTIONS IN DETAIL

NOTE: The bold panel in each table indicates the default value.

8.5.1 Output Power Level (Option 1)

The power level option allows the shocking power of the fence to be adjusted. The value entered is the Voltage level in 100's of volts.

The Default setting is 85 (8.5kV), the Maximum is 99.

For example: To change the power level to 6.8kV, enter 0168#.

The keypad will beep twice to indicate that the new option has been accepted. The actual fence voltage depends on the amount of fence wire and fence conditions.

This option may affect the average power drain and therefore backup battery time.

Energiser Function	Key1	Key2	Key3	Key4	Key5
High Power Level	0	1	100's volts		#

8.5.2 Low Power Mode Output Voltage (Option 2)

Same as above, but for Low Power mode.

The Default setting is 11 (1.1kV), the Maximum is 20.

Energiser Function	Key1	Key2	Key3	Key4	Key5
Low Power Level	0	2	100's volts		#

8.5.3 Fence Return 1 Alarm Voltage (Option 3)

This option sets the voltage threshold below which the fence alarm will occur. The value entered is the Voltage level in 100's of volts.

The Default setting is 40 (4.0kV), the Maximum is 60.

Energiser Function	Key1	Key2	Key3	Key4	Key5
Fence Return 1 Alarm Voltage	0	3	100's volts		#

8.5.4 Fence Return 2 Alarm Voltage (Option 4)

This option sets the voltage threshold below which the fence alarm will occur. The value entered is the Voltage level in 100's of volts.

The Default setting is 40 (4.0kV), the Maximum is 60.

Energiser Function	Key1	Key2	Key3	Key4	Key5
Fence Return 2 Alarm Voltage	0	4	100's volts		#

8.5.5 Fence Return Alarm Voltage for Low Power Mode (Option 5)

This option sets the voltage threshold below which the fence alarm will occur.

The Default setting is 05 (0.5kV), the Maximum is 15 (1.5kV).

Energiser Function	Key1	Key2	Key3	Key4	Key5
Fence Return Alarm Voltage for Low Power mode	0	5	100's volts		#

8.5.6 Missed Pulse Count (Option 6)

This option sets the number of bad or missing pulses that are counted before the alarm occurs.

The Default setting is 03, the Maximum is 99.

NOTE: The lower this option is set, the more likely you are to get false alarms.

Energiser Function	Key1	Key2	Key3	Key4	Key5
Missed Pulse Count	0	6	New Value	#	

Battery Alarm Voltage (Option 7)

This option sets the battery voltage threshold below which the alarm will activate. The default Battery Alarm Voltage is 10.0 Volts and the unit will drop to low power at 9.0 Volts (after beeping 4 times).

If the unit enters Low Power mode due to a flat battery, the unit will automatically return to high voltage, without warning, when the mains voltage comes back on and the battery voltage rises.

Key3	Alarm	Reduce Power
0	9.0V	8.0V
1	9.5V	8.5V
2	10.0V	9.0V
3	10.5V	9.5V
4	11.0V	10.0V
5	11.5V	10.5V
6	12.0V	11.0V
7	12.5V	11.5V
8	13.0V	12.0V
9	13.5V	12.5V

8.5.7 Siren On Time (Option 8)

This option sets the duration of time that the siren will remain on after a fence alarm occurs. After this time the siren will turn off for the Siren Off Time. The siren will sound again if the alarm is still present after this Siren Off Time has passed.

The default is 2 minutes. This may be the subject of local regulations to stop an alarm causing undue disturbance to neighbours, etc.

NOTE: The Siren On Time will be cut short if the battery falls below the low battery level.

Key3	Time
0	10 Seconds
1	30 Seconds
2	1 Minute
3	2 Minutes
4	3 Minutes
5	4 Minutes
6	5 Minutes
7	20 Minutes
8	45 Minutes
9	130 Minutes

Siren Off time (Option 9)

This option sets the amount of time the siren will be off for after the “Siren On Time” above has expired. If an alarm is still present after this off time, the siren will sound again.

Key3	Time
0	10 Seconds
1	1 Minute
2	2 Minute
3	5 Minutes
4	10 Minutes
5	20 Minutes

Key3	Time
6	30 Minutes
7	40 Minutes
8	50 Minutes
9	60 Minutes

8.5.8 Siren Cycles (Option 10)

This option sets the maximum number of times the siren will sound for the “on time” if the alarm continues. This may be limited by local regulations to stop an alarm causing undue disturbance to neighbours, etc.

NOTE: This is the maximum number of cycles for 1 continuous alarm.

Key3	Cycles
0	1
1	1
2	2
3	3
4	4
5	5
6	6
7	7
8	8
9	9

8.5.9 Gate Entry/Exit Delay (Option 13)

The gate switch must remain open for longer than the Gate Entry/Exit Delay before the gate alarm is triggered.

Key3	Time
0	0 Seconds (Immediate)
1	30 Seconds
2	1 Minute
3	2 Minutes
4	3 Minutes
5	4 Minutes
6	5 Minutes
7	6 Minutes
8	7 Minutes
9	8 Minutes

8.5.10 Chime Mode (Option 14)

This option allows the energiser internal and keypad beeper to be used as a door chime for the gate switch. When set to None, the keypad beeper is used to indicate correct keypad operation only. When set to Door Chime mode, both beepers will sound when the gate switch opens, even if the energiser is disarmed.

NOTE: "Gate Function" must be selected for an input. If set to siren, both beepers mimic the siren function.

Gate Beeps plus Siren will give 2 beeps on gate open and 4 on close, plus continuous for an alarm. This option is different as beeps are on the keypad only, not the internal beeper.

Key3	Function
0	None
1	Door Chime
2	Siren
3	Fence Alarm
4	Gate beeps plus Siren

8.5.11 Combined Options (Option 16)

Each option in this table can be turned on by adding the corresponding value. E.g., if you require maximum power at all times and you would like to enable the IR tamper circuit you would require option +2 and option +8 from the list below.

This equates to setting option 16 to 10 because $2 + 8 = 10$.

+2: Maximum power at all times. NOTE: Turning this option on may remove IEC standards compliance.

+4: Limits a Z25 to 2.5J per zone in group mode.

+8: Enables the IR tamper detection under the lid. J3 changes function to inhibit tamper.

+16: Stop slaves on E-16 (Comms Fail) if the communications from the group master is lost.

+32: Stops the energiser sending alarm memory to a PC, relay PCB or keypad. Set this to restore “unlatched” mode on a PAE201 relay PCB.

Key3 and 4	Function
0	None
+2	Max Power
+4	2.5 Joules Limit
+8	IR Tamper enabled
+16	Stop slave on comms fail
+32	Do not send Alarm memory

8.5.12 Anti-Bridging threshold (Option 17)

Anti-bridging has been designed to detect a section of fence being bypassed, and removed from circuit, by an intruder bridging the feed to returns together and then cutting the live wires in between.

Setting this option to a value greater than 0 (default is 0 = off) will enable Anti-bridging, however this feature will not operate in low power mode. While Armed, a fence alarm will trigger if the fence voltage rises OR falls quickly by more than the threshold. A slow change to the voltage will not trigger a fence alarm until the voltage is less than the Fence Alarm Voltage (Option 03).

The Anti-bridging Threshold is a percentage value of the current fence voltage. For Example, setting option 17 to 10 (1710#) will set a 10% Anti-bridging Threshold. At this level a fence (return) voltage normally reading 7.5kV will trigger a fence alarm if the voltage quickly rises to over 8.3kV or falls to less than 6.7kV.

NOTE: Power Level (option 1) must be set higher than the normal fence running voltage, otherwise if the load is released (fence bridged) voltage control will limit the voltage rise and the anti-bridging alarm will not activate. For the above example, option 1 must be set to 7 or greater to allow the unloaded fence to rise to 8.3kV or higher, thus triggering the Alarm.

8.5.13 Combined Options 2 (Option 18)

Each option in this table can be turned on by adding the corresponding value.

For option +1 set 18 to 01, for +1 and +2 set option 18 to 03.

+1: Enables Siren Acknowledge. The siren will chirp once for armed and twice for disarmed.

+2: Enables a home alarm style entry/exit delay for the gate input.

+4: Sets the keypad bus baud rate to 4800 (default is 2400), all units in a group, PC and keypad must be set to the same baud rate. The change will not take effect until after a reset.

+8: Sets the keypad bus baud rate to 9600 (default is 2400)

Key3	Function
0	None
+1	Siren codes
+2	Gate delay type
+4	4800 baud
+8	9600 baud

8.5.14 Auto Re-arm Time (Option 20)

This option sets the time which must elapse before another alarm will sound after the first alarm has timed out (gone completely through its cycles without being turned off). If an event occurs (such as a low fence voltage) which triggers the siren, any other events which would otherwise trigger the siren (such as a gate alarm) will be ignored while the siren is sounding and until after the Auto Re-arm time has passed. A setting of 0 will disable Auto Re-arm.

If this time is set to less than the Siren Off Time, the Energiser may re-arm in the "Off" time and the number of Siren Cycles will be reduced.

Key3	Time
0	0 Seconds (Immediate)
1	30 Seconds
2	1 Minute
3	2 Minutes
4	3 Minutes
5	4 Minutes
6	5 Minutes
7	6 Minutes
8	7 Minutes
9	Disabled – Do not auto rearm

Programming Options

8.5.15 Relay Programming

All relays can be set to any of the available functions (user assignable).

Command	Key1	Key2	Keys 3 and 4	Key 5
Relay 1	2	1	Default is 08	#
Relay 2	2	2	Default is 09	#
Relay 3	2	3	Default is 00	#

Relay Functions

The table below is for use for the relay programming options mentioned in the above table.

Key3 4	Function	Description
00	Fence 1	Triggers when Zone 1 is armed and return voltage is below set threshold voltage
01	Fence 1 or Off	Triggers when Zone 1 is off or return voltage is below the threshold voltage
02	Armed 1	Zone 1 is armed
03	Fence 2	Triggers when Zone 2 is armed and return voltage is below set threshold voltage
04	Fence 2 or Off	Triggers when Zone 2 is off or return voltage is below the threshold voltage
05	Armed 2	Zone 2 is armed
07	General	Triggers on AC Fail, Tamper, Low Battery/Bad Battery, Gate Alarm or Internal error. Latched (internal errors only)
08	Siren	Triggers on Fence alarm , Gate or tamper. Will time out after the Siren Time Out time. Latched

Key3 4	Function	Description
09	Strobe 1	Triggers on Fence 1 alarm, Gate or Tamper. Only turns off on Energiser disarm.
10	AC Fail	Triggers on AC Fail
11	Low/Bad Battery	Triggers on low or bad battery
12	Tamper	Triggers when the case has been opened and J3 has been fitted
13	Strobe 2	Triggers on Fence 2 alarm, Gate or Tamper. Only turns off on Energiser disarm.
14	Gate 1 or 2	Triggers on Gate 1 or Gate 2 alarm
15	Gate Siren	Behaves like siren, only for Gate alarms
16	Armed Low Power	Triggers when armed in Low Power mode
17	Group Armed	Triggers when group is armed. Only configurable on group master.
18	Group general	Triggers on group general alarm. Only configurable on group master.
20	Host Control	This Relay is completely controlled from a Host system such as Perimeter Patrol or a Keypad. If the Host system is disconnected from the Energiser for more than 30 seconds, the Relay will automatically change to the Alarm State
21	Host Control - Not Fail Safe	This Relay Host Controlled however if the Host system is disconnected then the Relay will maintain its current state

NOTE: The siren and strobe switched 12V outputs can be used to drive external buffer relays.

8.5.16 Group Mode (Option 26)

A group of Energisers must have only one master. The other Z-Series devices in the group are slaves. Each energiser in the group must have a different value programmed into Option 26. Since the keypad bus is common among the group, one keypad can be used to program all units for all options except this Group Mode (for obvious reasons).

The procedure is:

- Connect the keypad directly each Energiser in turn
- Program the Group Mode value for that Energiser
- Link all Z-Series devices (via the Keypad Bus) into a group

Key 3 and Key 4	00	01	02	xx	15
Group Mode	No Group	Group Master	Zone 2	Etc	Zone 15

8.5.17 Input Function and Trigger

Each Input is configured independently using two digits to configure the Trigger followed by the Function.

Input 1 is Option 27. **Default setting is 00** - Normally Open Input with Arm/Disarm Function

Input 2 is Option 28. **Default setting is 16** - Normally Closed Input with a Gate 1 Function

Input 3 is Option 29. **Default setting is 17** - Normally Closed Input with a Gate 2 Function

Key3	Input Trigger	Key4	Input Function
0	Normally Open (Active when Closed)	0	Arm / Disarm all Zones
1	Normally Closed (Active when Open)	1	Arm / Disarm Zone 1
2	Momentary Toggle (Toggle between states)	2	Arm / Disarm Zone 2
3	NO Pulse Extend (Extend a short Close signal by 3 seconds)	3	Low Power when Active / High Power otherwise. Requires Energiser to be Armed
4	NC Pulse Extend (Extend a short Open signal by 3 seconds)	4	Low Power Zone 1 (As per Function 3)
		5	Low Power Zone 2 (As per Function 3)
		6	Gate 1 is Open when Active / Closed otherwise
		7	Gate 2 is Open when Active / Closed otherwise
		8	Tamper Alarm triggered when Active
		9	Pass Through input signal to other device

9 SPECIFICATIONS

9.1 Z25 SPECIFICATION

Specification Name	Specification
Energiser Output Voltage	9.5kV peak no load
Peak Output Energy	2.5 Joules at 500 Ohms
Pulse Rate	Locked at 0.8 Hz
12Vdc Power Consumption	Energiser on – 550mA average, 700mA peak Energiser off – 28mA (40mA with keypad) Not including keypad or auxiliary power
AC Power Input	16-18Vac
Battery Charger Output	Float voltage 14V, 500mA, short circuit and reverse polarity protection utilising 3A slow SMD fuses.
L1+, L2+ and Siren Outputs	Self-resetting fuse protection, switched 12V, rated at 30W (combined)
Enclosure	IP4x ABS plastic
Size	300mm high, 190mm wide, 115mm deep
Weight – packed, no battery	1.9kg



- There are no user-serviceable parts in this unit.
- The installer is reminded that high voltages are retained for a while after switching off, and to wait for at least 10 minutes before opening the case.
- Before working on the high voltage wiring of an electric fence, it is recommended that the energiser be turned off and an intentional short circuit be placed from the fence live wires to earth.
- Electric fences are not toys; do not let children play with them.

This appliance is not intended for use by persons (including children) with reduced physical, sensory or mental capabilities, or lack of experience and knowledge, unless they have been given supervision or instruction concerning use of the appliance by a person responsible for their safety. Children should be supervised to ensure that they do not play with the appliance.

10 Z-SERIES KEYPADS

There are 2 different keypads that can connect to the keypad bus of a Z-Series device:

- PTE0210 LCD keypad
- PTE0230 Touch Keypad

Both devices can be used to control, program and monitor the devices on your fence.

10.1 PTE0210 LCD KEYPAD



The PTE0210 is an easy to use, durable and economical LCD keypad that can be used to control and program all Z-Series devices. It displays fence information such as fence voltages, battery voltages and any alarms if and when they occur. The onboard beeper alerts the user to any issues and instantly shows the relevant information that the user needs to see.



JVA's most advanced keypad features include:

- Touch screen with clean user interface designed for ease of use
- Quickly arm or disarm the entire site or granularly via the Zones screen
- Emails on alarm
- View all active and latched alarms in the alarms screen
- Program all Z-Series devices through an intuitive system, without having to remember or refer to a manual for key sequences. With the new MK2 protocol, these devices can be all programmed together without having to isolate each device individually
- Quiet mode: set a time where the Keypad won't brighten the screen or set off loud sirens unless it is critical such that you might enjoy a restful night's sleep.
- The ability to monitor and log all user actions
- Can be used to maintain a log on a Perimeter Patrol managed system in case the PC goes down or the TCP/IP connection from the PAE212 to the PC is lost. Note for all information to be captured each sub group will require PTE0230 Touch Keypad

10.3 LCD KEYPAD OPERATION

10.3.1 Wiring up your Z-Series LCD Keypad

The following diagram shows how to Wire up a Z-Series LCD keypad.

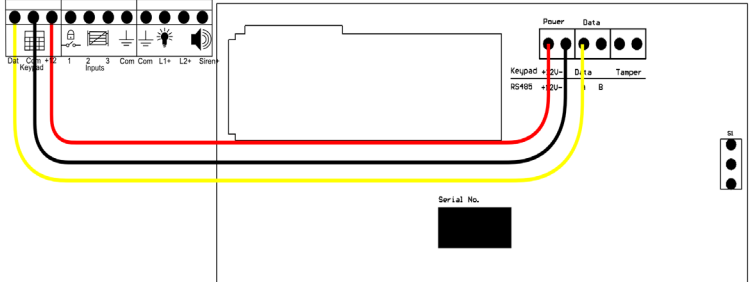

Remove the rear of the LCD keypad to expose the wiring terminals shown in the diagram above.

10.3.2 Keypad status LEDs

The LCD keypad has two LEDs, Power and Arm, which act as follows:

- Power On with Mains power, flashes on low battery.
- Arm On When the energiser is armed (pulsing), flashes when in Low Power Mode.

10.3.3 Arming/Disarming the Fence Using the Keypad

Function	Code	Default Code
Arm	[User PIN] #	1234#
Disarm	[User PIN] #	1234#

LCD Keypad arm/disarm codes. Default code uses the default User pin

Enter your [User PIN] and push the # key. Make sure the red ARM light comes on and the keypad beeps twice to confirm that the system is armed.

The fence will power up and if all is well (no faults) the system will be ready to deter and detect.

To disarm the system, enter your [User PIN] and press #.

NOTE: If there is an alarm sounding you will need to enter your [User PIN] twice, once to silence the alarm and once more to disarm.

10.3.4 Menus

The Z-Series keypad has an optional menu driven interface. The main menu is accessed by pressing the Menu key (bottom right). You will be asked to enter your PIN, and then press #.

Most functions are available via the menus. Use the 2 key to go up and the 8 to step down through a menu. The Enter (#) key is used to select the current line.

The menu will time out after a few minutes and return to the normal status display.

10.3.5 Keypad Status Display

In normal operation the keypad shows a continuous summary of the system status. For example if the system is disarmed the keypad will display “Ready to Arm”.

If the system is armed then the keypad will display the voltages for each zone in the system.

Since there can be many things to display the keypad automatically “scrolls” through all relevant information. Each screen is shown for about 2 seconds. If you wish to hold the display at a particular point simply press the # key. The auto scrolling will stop for about 20 seconds.

Pressing the # key again will advance the display one step.

If a new trouble (AC fail, low battery etc) or alarm occurs, the keypad screen will jump to the relevant zone, the keypad will beep (unless toggled off) and auto scrolling will cease for about 3 minutes.

10.3.6 Changing the Keypad Messages and Address

Function	Code	Default Code
Enter Keypad Programming mode	[Installer Pin] *01#	012345*01#
Exit Keypad Programming mode	*#	*#

LCD Keypad Programming mode commands. Default Code uses default Installer Pin

You can change the messages and each of the zone labels.

- The Dealer Message displays when the system is on standby.
- Zone Labels displays after the # key is pressed during alarm memory or faults.
- The programmable Service Message is displayed during AC failure, communication failure, or low battery.

[1]	[2] Character up	[3] not used	Emergency not used
[4] Cursor left	[5] Next Message	[6] Cursor right	Fire not used
[7]	[8] Character down	[9]	Panic
[*]	[0] Last Message	[#] Enter/Exit	Bypass not used

Keys used for changing messages

To activate the keypad programming mode, enter the [Installer PIN] *, 0, 1, #. Information may be entered into the keypad in the form of letters (upper and lower case), numbers (0 - 9), and 22 special symbols. All characters are displayed in the order: upper and lower case letters, numbers, and special symbols. The [Space] character precedes the letter A.

To enter a Label, use the [2] key to scroll through the characters until you reach the desired character. If you scroll past the desired character, the [8] key may be used to scroll backwards.

NOTE: The space character is before the A character (When A is displayed, press [8] to get a space).

When the desired character is displayed, press the [6] key to move the cursor to the next character position. The [4] key moves the cursor to the left.

NOTE:

1. If you move to the next message using [5] instead of the [#] key you will lose any changes you made!
2. To change the keypad address, scroll through the messages until the keypad displays: "Keypad address __" then change the value by pressing [2] (up) or [8] (down). Submit the change by pressing [#].

The message order is:

- SERVICE MESSAGE (Displayed under "System Trouble")
- DEALER MESSAGE (Displayed under the standby message: "Ready to Arm")
- ZONE NAMES

- BAUD RATE (should be left at 2400)
- KEYPAD ADDRESS (should be left at 1)

10.4 TO EXIT KEYPAD PROGRAMMING

When you have finished programming, press * #.

NOTE: The keypad will also exit the programming mode if you do not press any key within a five minute period.

To return the Keypad to default settings press the emergency button



during power up

10.5 CONNECTING MULTIPLE KEYPADS TO A SYSTEM

Function	Code	Default Code
Re-analyse the Keypad group	[User Pin]*68#	1234*68#

Up to three keypads may be used to remotely monitor and control Z-Series devices.

To operate correctly, each keypad must be configured to use a unique keypad address. This is best achieved by connecting one keypad (at a time) to the master Z-Series device and updating the keypad address. Once all keypads have a different address, all can be connected to the system. A recommendation is that one keypad is kept at address 1.

The Z-Series device now needs to be introduced to all of these keypads. This is achieved by resetting the Z-Series device using the keypad (configured to address 1), by pressing [User PIN]*68#. Alternately the power can also be removed to reset the Z-Series device. After a reset, the Z-Series device will determine what keypads are connected, and only these addresses will be used in the future. This prevents unauthorised keypads being added to the system once it is running.

NOTE: If the security system is to use Perimeter Patrol, keypad address 2 should not be used by a keypad because that is the default keypad address that Perimeter Patrol uses.

10.6 NOTES REGARDING KEYPAD CONFIGURATION

Zone 1 (the master) must be connected to the group. If it is not connected to the other Z-Series devices in the group, it will not send its data to the keypad; Data such as voltages and alarm information which the keypad displays. If Zone 1 is not connected, the keypad will report a communications failure with all the zones.

A Slave Z-Series device that is disconnected from the group will only talk to a keypad if it has a keypad address of 1. When adding or removing a Z-Series device to or from the group, or if you have changed a device ID, be sure to re-analyse the group using the key sequence [User PIN] * 6 8 #. Zone 1 (the master) must be connected to the group for this operation to work.

NOTE:

1. When re-analysing a group ensure all Z-Series device are disarmed; if they are not this function will not work properly.
2. If the group ID has recently been changed you may need to reset, [User Pin] * 6 8 # before the new ID's will be properly reported to the keypad.

10.7 CALIBRATING THE VOLTAGE DISPLAY

The PCB's will be factory calibrated and should not require adjustment for the life of the product. If, however, certain components are replaced during repair the Energiser may need recalibration. This includes the main processor chip.

Procedure:

1. On the energiser Fence connectors, connect Return to Feed terminals and Earth (Return) to Earth (Feed) terminals.
2. Plug in the keypad, power the unit and turn on the energiser using the key-switch.

Clearing old calibration using the keypad:

3. Type [Installer's Code] *, 0, # Enter programming mode.
4. Type 9, 8, 0, 0, # Clear the calibration for the Left value.
5. Type 9, 9, 0, 0, # Clear the calibration for the Right value.
6. Type *, # Exit programming mode.

Once the calibration is cleared, run the energiser and record the actual voltages produced by the energiser using a fence meter. Record the values displayed on the LCD. The actual voltages must be higher than the values displayed on the LCD for calibration to work.

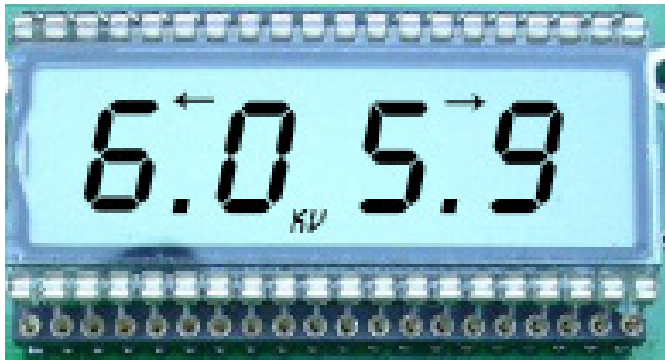

Left Value (Return 1)

Right Value (Return 2)

7. Calculate the return calibration factor

$$(\text{Actual Voltage} * 100 / \text{Displayed voltage}) - 100$$

For example If after clearing the calibration the Actual fence voltage is 7.1 but the display left value reads 6.0 (as per the picture above) the factor is:

$$(7.1 * 100) / 6.0 = 118.3$$

$$118.3 - 100 = 18.3 \text{ (Ignore the value after the decimal point)}$$

For the Left value, the factor to enter is 18 (an increase of 18 percent).

Using the same process for the Right value (above picture shows 5.9kV),

For the right value, the factor to enter would be 20.

Entering new calibrations using the keypad (for our example)

8. Type [Installer's Code] *, 0, # Enter programming mode.
9. Type 9, 8, 1, 8, # Enter the Left calibration.
10. Type 9, 9, 2, 0, # Enter the Right calibration.
11. Type *, #. Exit programming mode.

10.8 USING THE PTE0230 TOUCH KEYPAD

10.8.1 Screens

The PTE0230 Touch Keypad consists of the following screens:

- Home
- Alarms
- Settings
- Events
- Zones
- Zone Details
- Program Devices

10.8.2 Home Screen

This is the first screen you are presented with when the ZKeypad Application starts. This screen acts as a gateway to all the other screens.



Key

1. Home button – returns you to the home screen.
2. Back button – this will show the previous screen.
3. Site state/alarm screen button – if the keypad is in alarm, launches the Alarm screen, otherwise it shows site information.

4. Help button – launches the keypad help documentation.
5. Login/logout button – provides pin entry dialog if a user is not logged in. Or if a user is logged in allows them to logout. The above screenshot shows that the installer is logged in.
6. Alarms Screen Button – Launches the Alarms Screen, this will only appear when there are active alarms.
7. Settings screen button – launches the Settings screen.
8. Events screen button – launches the Events screen.
9. Zones screen button – launches the Zone Details screen.
10. Site disarm button – disarms the site, privileges permitting.
11. Site high power button – arms the site in high power mode, privileges permitting.
12. Site low power button – arms the site in low power mode, privileges permitting.
13. Panic Button - Pressing this will send the panic command out, activating the sirens.

10.8.3 Alarm Screen

This screen can be accessed by clicking the header bar (where it currently states “Ready to Arm – Maintenance required” in the image below) when the keypad is in alarm or by clicking the dedicated alarms screen button. From within the screen the alarms can be dismissed by clicking the Clear all button.

NOTE: The Clear All Button will only clear latched alarms that have been resolved.

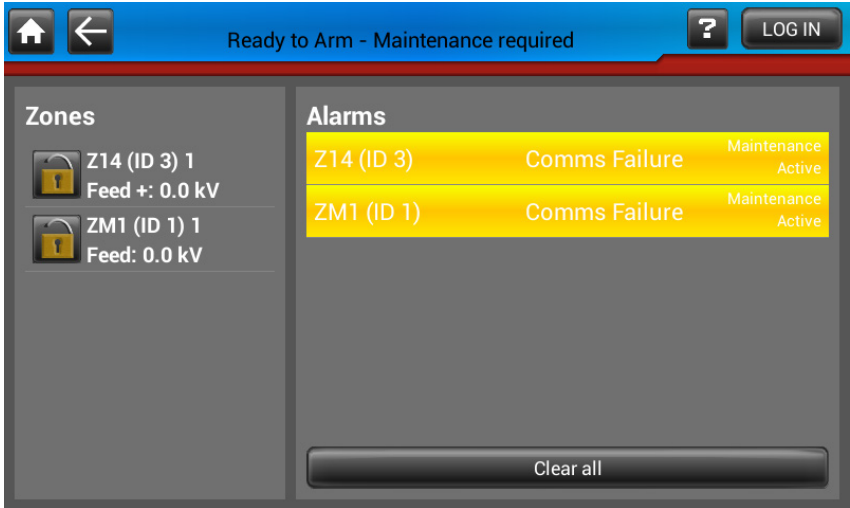

10.8.4 Settings Screen

This screen allows the user to adjust preferences such as the screen brightness, zone names and other application preferences

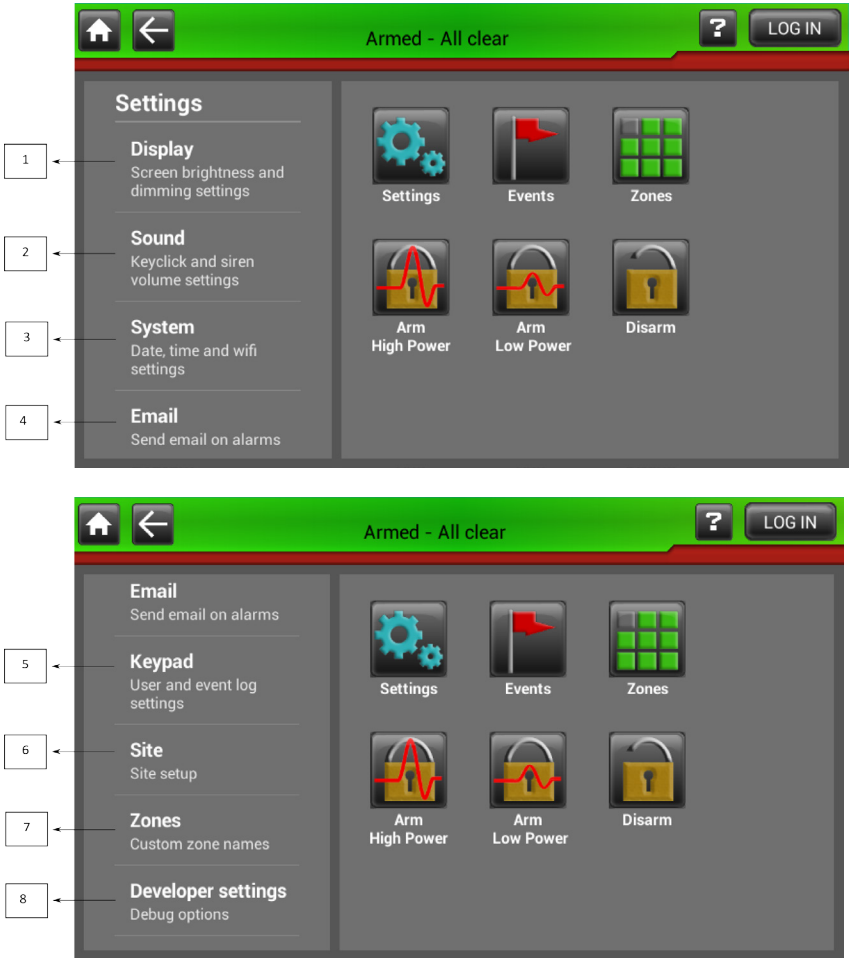

Key

1. Display – Contains brightness settings.
2. Sound – keyclick and alarm volume settings.
3. System – date and time and Wi-Fi settings.
4. Email – for configuring email notifications for alarms.

5. Keypad – change user pin, automatic logout time, and event log settings.
6. Site – home screen customisation and site configuration settings – installer only.
7. Zones – allows zones to be renamed, to be more memorable – installer only.
8. Developer settings – this contains diagnostic information – installer only.

Display

- Manual Brightness - if checked will enable the Brightness slider allowing you to select the application brightness manually. If unchecked the brightness will be set automatically.
- Screen Dims – This option sets the idle time required before the screen dims.

Sound

- Keyclick volume – slider that adjusts the click volume that plays when a button is pressed.
- Siren volume – slider that adjusts the siren volume that plays when an alarm is detected.
- Siren mutes – option that allows you to adjust how long the siren will play for before being disabled.

System

- Set date and time – This option sets the systems date and time
- Wi-Fi settings – This option launches the Wi-Fi Settings such that the tablet can connect to a local Wi-Fi network.

Email

- These settings allow the tablet to be configured to email up to two email addresses when a fence alarm occurs. This can be configured such that only certain alarms will cause an email to be sent.

Keypad

- Automatically logout – setting for the amount of time that needs to expire before automatic logout.

- User Pin – This setting allows you to change the pin required for logging on as a user.
- Delete events – this option adjusts how many days worth of events are stored and displayed in the events screen. If a Micro SD card has been inserted the device will backup all events to this but will only display the amount of days worth of events selected here.
- Show all events – This option toggles whether or not the event log shows all system events or just the important ones.
- Quiet Hours - this setting when enabled allows the user to specify a time frame where only the most critical of alarms sound the onboard speaker and brighten the screen. In this way the user can have a good nights sleep and deal with any maintenance issues the following morning.

Site - Installer Only

- Installer details - by editing this text field you can adjust what is displayed on the home screen under the JVA logo.
- Site Name – This setting allows the Site name to be set. This name is used when emails are sent and for the file name when the site is saved.
- Clear site - this clears all the devices that are currently in the site.
- Save Site – This allows the current sites configuration to be saved to the SD card.
- Load Site – This setting allows a site's settings to be loaded into the keypad without having to configure the site manually.
- Auto-build zones - by checking this any devices that are added to the site are automatically detected and displayed by the keypad.
- Program devices – This launches the program devices screen which is explained in further detail below.
- Keypad id - this is where the keypad id is set.
- Baud rate - this is where the baud rate is set.
- Installer pin - This setting allows you to change the pin required for logging on as an installer.

Zones

- This shows all the zones in the site that have been detected by the key-

pad. By clicking on each zone they can be renamed to something more intuitive to the user.

10.8.5 Events Screen

This screen allows you to view all the events that have been logged by the keypad over the set amount of days set in the keypad settings.



Date	Time	Source	Description
1981-03-19	19:25:11	Z14 (ID 3)	Comms Failure Cleared
1981-03-19	19:25:11	ZM1 (ID 1)	Comms Failure Cleared
1981-03-19	19:25:06	ZM1 (ID 1)	Comms Failure Active
1981-03-19	19:25:06	Z14 (ID 3)	Comms Failure Active
1981-03-19	19:24:18	Z14 (ID 3)	Comms Failure Cleared
1981-03-19	19:24:18	ZM1 (ID 1)	Comms Failure Cleared
1981-03-19	19:23:15	ZM1 (ID 1)	Comms Failure Active
1981-03-19	19:23:14	Z14 (ID 3)	Comms Failure Active
1981-03-17	03:18:24	Installer	Developer preferences
1981-03-17	03:17:57	Installer	Zone names
1981-03-17	03:15:38	Installer	Site preferences
1981-03-17	03:15:04	Installer	Keypad preferences

10.8.6 Zones and Zone Details Screen

The zones screen (left) displays the zones that are currently in the site and by selecting one you can find further information about the zone in the zone details screen (Right). In the zone details screen you can set the currently selected zone to high or low power as well as the ability to disarm it.

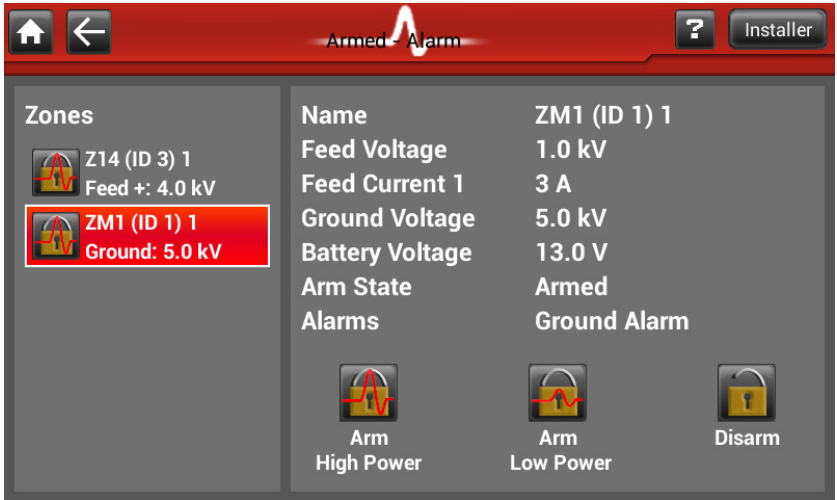

10.8.7 Program Devices Screen

This screen is opened via the Program Devices button in the Site settings. This Screen allows an installer to configure each energiser quickly without having to slowly enter key combinations whilst referring to a manual. If the site energisers are all running the MK2 protocol, you can program each device without having to connect to them individually. To start Programming, choose a device from the list to the left. The Keypad will automatically enter programming mode for that device and read its current programmed settings. These settings will appear on the list to the right. At this point you can begin to edit the settings, upon changing them, their colour will change to red indicating that you have yet to program these to the Z-Series device. To do this, press the program button. After programming the device you may wish to save the currently set up programming options to save time next time. To save the configuration press 'Save to SD Card' give the file an appropriate name and press save. You can load this configuration back at any time by pressing the 'Load from SD Card button'.

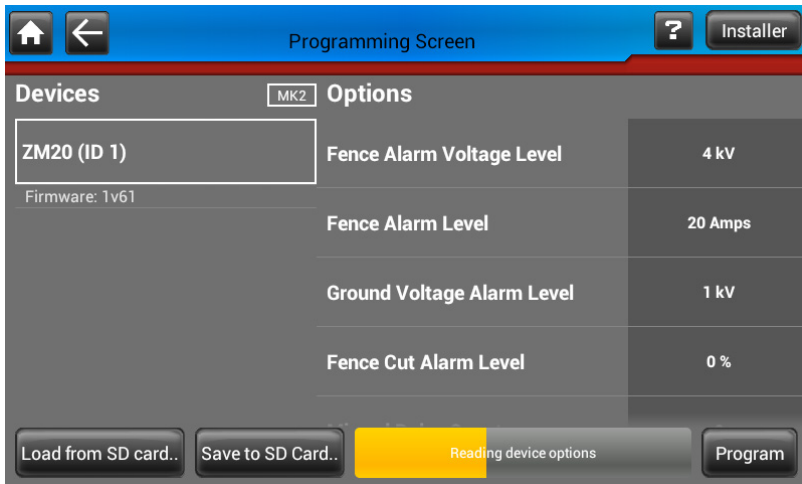

Screenshot above showing when a device is first selected from the left list

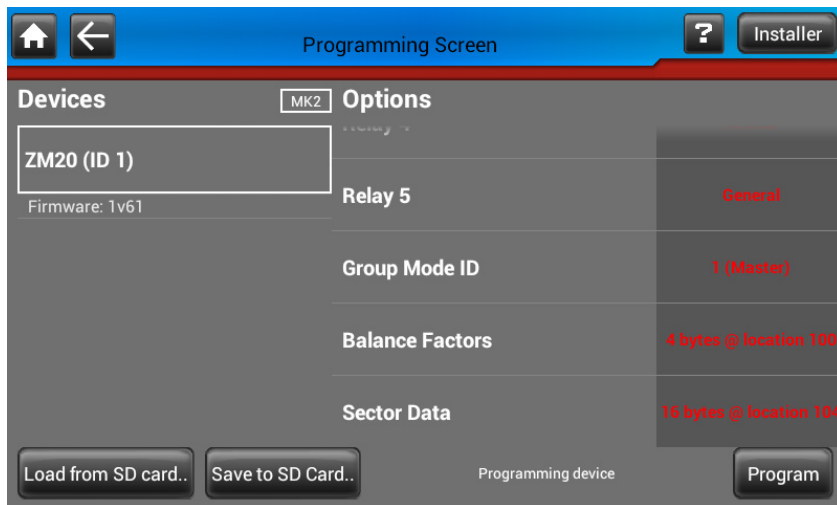

Screenshot above showing changed values turning to red

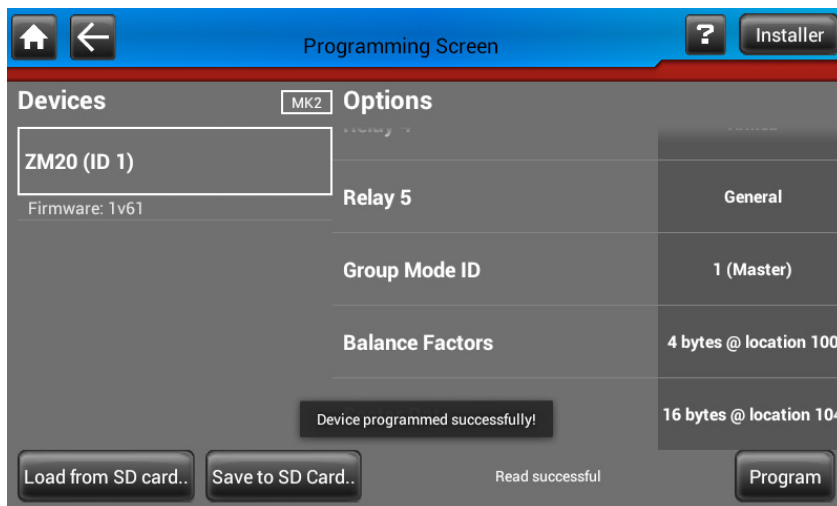

Screenshot above showing a device that has been successfully programmed

11 REMOTE CONTROL UNIT

The Remote Control Unit provides the Z25 with the ability to arm or disarm the energiser via a compact key chain fob remote control.

Two remote controls are provided, and are uniquely coupled to the receiver using a rolling code algorithm to ensure security. Should one or both remote controls lose synchronisation with the receiver, it is a simple procedure to re-associate the remotes.

The receiver controls the energiser by IN1 and receives power from the Keypad bus. The output of the remote control receiver is a normally open (NO) contact.

The remote controls have a range of up to 100 metres. They come fitted with a LR27A 12V battery that will provide up to 2 years service.

To get some auditory feedback as to whether you have armed or disarmed the fence you can install a siren into the siren output of the Z25. Then, using your Z-Series keypad, enter programming mode and set combined option 2 to 01. This will make your siren chirp once for armed and twice for disarmed. For more information see “8.5.13 Combined Options 2 (Option 18)” on page 48.

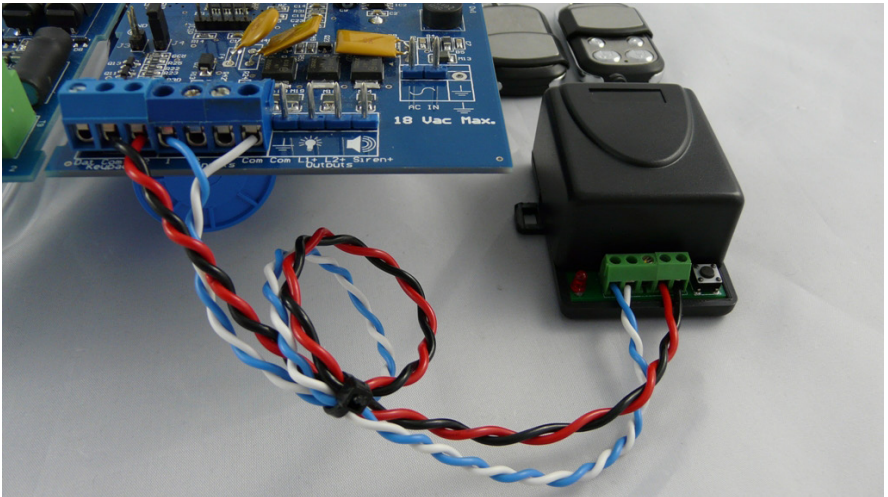

Remote Control Unit Receiver

11.1 FEATURES

- Enables arm / disarm of the energiser, or a single zone, by key chain fob remote control
- 2 remote controls included
- Uses digital rolling-code algorithm to uniquely and securely couple to remote controls
- Operates between 315 – 433.92MHz
- 100 metres range
- Easily connected and configured
- Wire to keypad bus (for power) and input (usually IN1)

11.2 INSTALLATION

The Remote control receiver unit requires 12V and 0V (GND) from the keypad bus, and its output is shown wired to IN1.

Mount the receiver on the right hand side of the Z25 energiser. Connect +12V and 0V (GND) from the KEYPAD terminals on the energiser to the right-most terminals of the receiver, as per the diagram above.

Connect the IN1 terminals to the left-most terminals of the receiver.

Keep all connections away from any high voltage wiring, specifically the Fence Feed connections coming from the left side of the energiser.

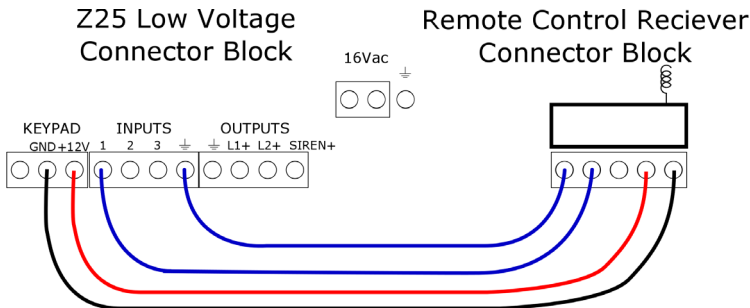

Remote Control Receiver Wiring Diagram

11.3 OPERATION AND CONFIGURATION

The remote controls come pre-configured to work with the receiver. Simply press the LOCK key to arm the energiser. Press the UNLOCK key to disarm.

Should a remote control become lost or stolen, it is possible to disassociate the receiver with all remote controls. To do this, press the button on the bottom right corner of the receiver unit and hold for approximately 10 seconds. When the red light goes off the receiver has wiped all associated remote controls from its memory.

To associate a remote control, press the same button on the receiver once. The light will come on momentarily. Next, press a button on the desired remote control. The receiver light will begin flashing. Press the same button on the receiver once more and the light will stop flashing. Test the remote control by pressing a button. The receiver light will flash, indicating it has successfully associated with the remote control. Repeat these steps for any remaining remote controls that require (re)association.

12 STANDARD REQUIREMENTS FOR SECURITY ELECTRIC FENCES

12.1 DEFINITIONS

Connecting lead

An electric conductor, used to connect the **energiser** to the **electric fence** or the earth **electrode**

Electric animal fence

An **electric fence** used to contain animals within or exclude animals from a particular area

Electric fence

A barrier which includes one or more electric conductors, insulated from earth, to which electric pulses are applied by an **energiser**

Electric security fence

A fence used for security purposes which comprises an **electric fence** and a physical barrier electrically isolated from the **electric fence**

12.2 GENERAL REQUIREMENTS FOR ELECTRIC FENCES

1. **Electric fences** shall be installed and operated so that they cause no electrical hazard to persons, animals or their surroundings.
2. **Electric fence** constructions which are likely to lead to the entanglement of animals or persons shall be avoided.
3. INSTALLERS/USERS SHOULD NOTE: WARNING: Avoid contacting electric fence wires especially with the head, neck or torso. Do not climb over, through or under a multi-wire electric fence. Use a gate or a specially designed crossing point.
4. An electric fence shall not be supplied from two different energisers or from independent fence circuits of the same energiser. For any two different electric fences, each supplied from a different energiser independently timed, the distance between the wires of the two electric fences shall be at least 2.5 m. If this gap is to be closed, this shall be affected by means of electrically non-conductive material or an isolated metal barrier.

5. Barbed wire or razor wire shall not be electrified by an **energiser**.
6. Any part of an **electric fence** which is installed along a public road or pathway shall be identified at frequent intervals by warning plates securely fastened to the fence posts or firmly clamped to the fence wires.
 - The size of the warning plates shall be at least 100 mm x 200 mm.
 - The background colour of both sides of the warning plate shall be yellow. The colour on the plate shall be black and shall be either:
 - The symbol of figure 7, or
 - The substance of “Caution - ELECTRIC FENCE”.
 - The inscription shall be indelible, inscribed on both sides of the warning plate and have a height of at least 25 mm.

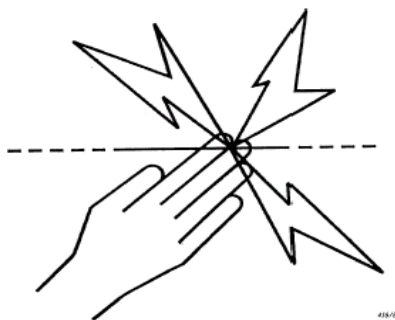

Warning plate symbol

7. The energiser earth **electrode** shall penetrate the ground to a depth of at least 1 m.
8. **Connecting leads** that are run inside buildings shall be effectively insulated from the earthed structural parts of the building. This may be achieved by using insulated high voltage cable.
9. **Connecting leads** that are run underground shall be run in a conduit of insulating material or else insulated high voltage cable shall be used. Care shall be taken to avoid damage to the connecting leads due to the effects of animal hooves or tractor wheels sinking into the ground.
10. **Connecting leads** shall not be installed in the same conduit as the mains supply wiring, communicating cables or data cables.
11. **Connecting leads** and electric fence wires shall not cross above overhead power or communication lines.

12. Crossings with overhead power lines shall be avoided wherever possible. If such a crossing cannot be avoided, it shall be made underneath the power line and as nearly as possible at right angles to it.
13. If **connecting leads** and **electric fence** wires are installed near an overhead power line, the clearances shall be not less than those shown in table.

Power line voltage (Volts)	Clearance (Meters)
<=1 000	3
>1 000 <=33 000	4
>33 000	8

Minimum Clearances from Power Lines

14. If **connecting leads** and **electric fence** wires are installed near an overhead power line, their height above the ground shall not exceed 2 m. This height applies either side of the orthogonal projection of the outermost conductors of the power line on the ground surface, for a distance of
- 2 m for power lines operating at a nominal voltage not exceeding 1,000 V.
 - 15 m for power lines operating at a nominal voltage exceeding 1,000V.

12.3 PARTICULAR REQUIREMENTS FOR ELECTRIC ANIMAL FENCES IN AUSTRALIA

1. A distance of at least 10 m shall be maintained between the **energiser earth electrode** and any other earthing system such as the power supply system protective earth or the telecommunication system earth.
2. **Electric fences** intended for deterring birds, household pet containment or training animals such as cows need only be supplied from low output **energisers** to obtain satisfactory and safe performance.
3. In **electric fences** intended for deterring birds from roosting on buildings, no **electric fence** wire shall be connected to the **energiser earth electrode**. A warning plate, as described above, shall be fitted to every point where persons may gain ready access to the conductors.
4. A non-electrified fence incorporating barbed wire or razor wire may be used to support one or more off-set electrified wires of an **electric**

animal fence. The supporting devices for the electrified wires shall be constructed so as to ensure that these wires are positioned at a minimum distance of 150 mm from the vertical plane of the non-electrified wires. The barbed wire and razor wire shall be earthed at regular intervals.

5. Where an **electric animal fence** crosses a public pathway, a non-electrified gate shall be incorporated in the **electric fence** at the point or a crossing by means of stiles shall be provided. At any such crossing, the adjacent electrified wires shall carry warning plates as described above.

12.4 INSTALLATION OF ELECTRIC SECURITY FENCES

12.4.1 General

An electric security fence should be installed so that, under normal conditions of operation, persons are protected against inadvertent contact with pulsed conductors.

NOTE:

1. This requirement is primarily intended to establish that a desirable level of safety is present or is being maintained in the physical barrier.
2. When selecting the type of physical barrier, the likely presence of young children should be a factor in considering the size of openings.

12.4.2 Location of electric security fence

The electric fence should be separated from the public access area by means of a physical barrier.

Where an electric fence is installed in an elevated position, such as on the inner side of a window or skylight, the physical barrier may be less than 1.5 m high where it covers the whole of the electric fence. If the bottom of the window or skylight is within a distance of 1.5 m from the floor or access level then the physical barrier need only extend up to a height of 1.5 m above the floor or access level.

12.4.3 Prohibited zone for pulsed conductors

Pulsed conductors shall not be installed within the shaded zone shown in Figure 8.

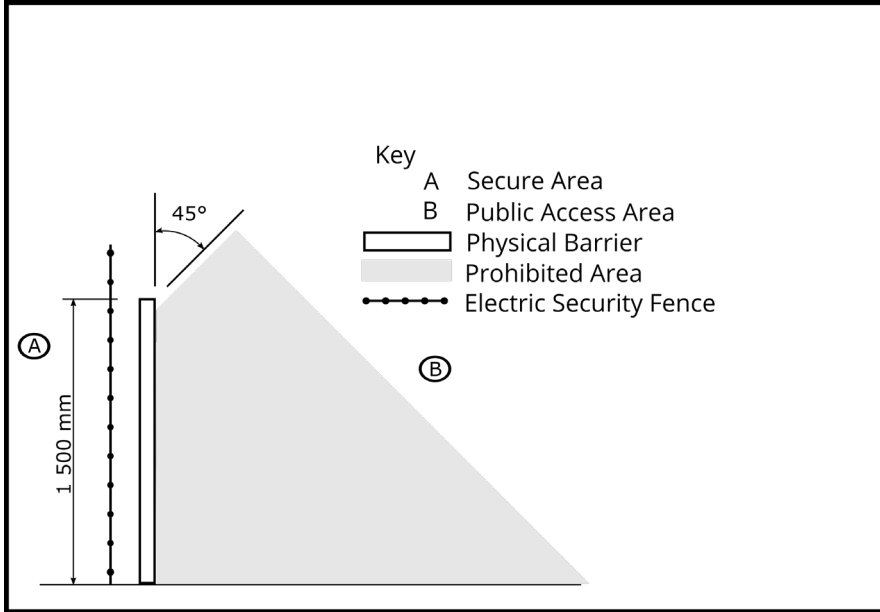

Prohibited Area for Pulse Conductors

NOTE: Where an electric security fence is planned to run close to a site boundary, the relevant government authority should be consulted before installation begins.

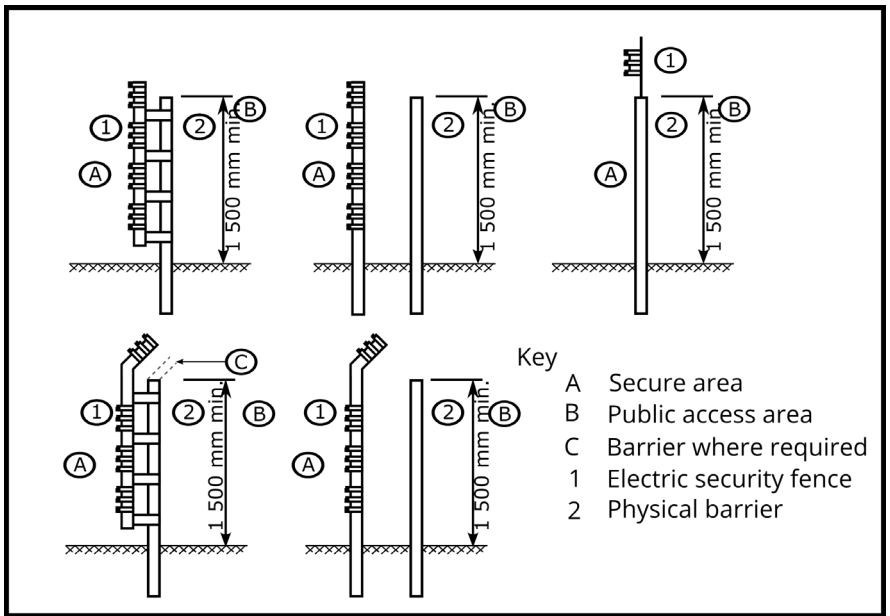

Typical Constructions where an Electric Security Fence is Exposed to the Public

NOTE: Typical electric security fence installations are shown in Figure 9 and Figure 10.

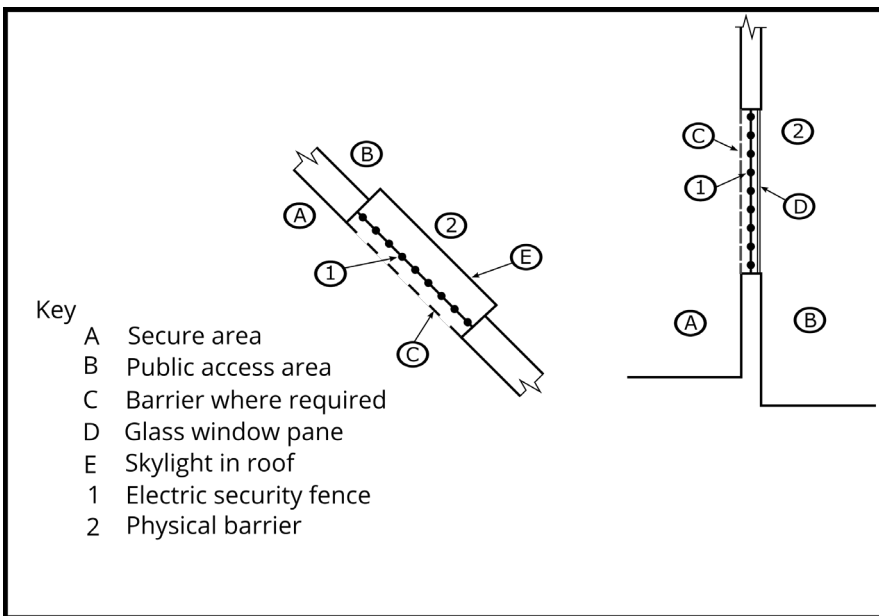

Typical fence constructions where the electric security fence is installed in windows and skylights

12.4.4 Separation between electric fence and physical barrier

Where a physical barrier is installed in compliance with 3 at least one dimension in any opening should be not greater than 130 mm and the separation between the electric fence and the physical barrier should be

- within the range of 100 mm to 200 mm or greater than 1 000 mm where at least one dimension in each opening in the physical barrier is not greater than 130 mm;
- greater than 1 000 mm where any opening in the physical barrier has all dimensions greater than 50 mm;
- less than 200 mm or greater than 1 000 mm where the physical barrier does not have any openings.

NOTE:

1. These restrictions are intended to reduce the possibility of persons making inadvertent contact with the pulsed conductors and to prevent them from becoming wedged between the electric fence and the physical barrier, thereby being exposed to multiple shocks from the energiser.

2. The separation is the perpendicular distance between the electric fence and the physical barrier.

12.4.5 Prohibited mounting

Electric fence conductors should not be mounted on a support used for any overhead power line.

12.4.6 Operation of electric security fence

The conductors of an electric fence should not be energized unless all authorized persons, within or entering the secure area, have been informed of its location.

Where there is a risk of persons being injured by a secondary cause, appropriate additional safety precautions should be taken.

NOTE: An example of a secondary cause is where a person may be expected to fall from a surface if contact is made with pulsed conductors.

13 APPENDIX A: GROUP SIMULTANEOUS PULSE FEATURE

13.1 GROUP SIMULTANEOUS PULSE FEATURE

In some Industrial Installations it may be preferable to provide the ability to link multiple Energisers into a group. When linked the individual Z-Series devices become a “Group”. Members of a group have simultaneous high voltage output pulses and act as if they are one energiser with multiple outputs. This is designed so that no possible combination of individual outputs can be dangerous.

13.2 GROUP MODE PROGRAMMING (OPTION 26)

A group **MUST** have only 1 master. The other Energisers in the group are slaves.

For the Z25 Energisers, if there is no Master, a Slave will display Error 4 on the Status LED when Armed and it will not electrify the fence. This is a requirement for Australian Standards.

For every other Z-Series device, if there is no Master, each Slave will electrify the fence (pulses) when Armed. However, the simultaneous pulse feature will **NOT** be operating.

NOTE:

1. Do not interconnect the energisers via the keypad bus until after they are programmed.
2. If more than one keypad is used, they will need different addresses (see “10.3.6 Changing the Keypad Messages and Address” on page 60).
3. If Perimeter Patrol is used any keypad in the system should not have address 2, (see “10.3.6 Changing the Keypad Messages and Address” on page 60).

For all Energisers that will be part of a group, the procedure is as follows:

1. Make sure the key switch is turned off and IN1 isn’t shorted.
2. Connect the battery.
3. On the keypad, enter [Installer’s code] *, 0, #.
4. Enter 2, 6 followed by the required value (e.g. 1 for master) then #.
5. Enter *, # to exit programming.

6. Connect the group using the keypad bus as the Group Mode Linking diagram.

NOTE: At this time groups are limited to a master and 14 slaves (15 zones total)

Key3	Mode
0	No Group
1	Master
2	Slave 1
3	Slave 2
4	Slave 3
5	Slave 4
6	Slave 5
7	Slave 6
8	Slave 7
9	Slave 8
10	Slave 9
11	Slave 10
12	Slave 11
13	Slave 12
14	Slave 13
15	Slave 14

13.3 GROUP LINKING VIA THE KEYPAD “BUS”

The keypad terminals on all Energisers in the group are linked. Since only one Energiser needs to power the keypad, 3 wires are linked from one Energiser (preferably the Master) to the keypad (optional) and 2 wires to every other Energiser in the group. Do not connect the + lines between Energisers as this could result in some strange behaviour and possibly damage.

NOTE the connections can be a star or daisy chain or any mixture. It is possible for a PC to be added to the group using a keypad to RS232 adaptor (PAE223).

We recommend following these steps in the right order:

1. Disarm all energisers in the group. If energisers are not disarmed Step 10 may not work correctly.
2. Program the keypad address using one of the energisers.
3. Program each energiser with its required address (Master address=1, Slave 1 address=2...).
4. Connect any control/monitoring unit 12V, GND and Data to the Group Master
5. Connect all the slaves Data and GND to the Group Master.
6. Connect the battery and AC power of the Group Master but do not arm.
7. Connect the battery and AC power of each slave. Note: Do not arm them until all the Energisers in the group are connected.
8. Wait 5 minutes for all the Energisers to synchronise with the Master
9. If there are more than one Z-Series keypad or control unit, make sure they have a different ID, then reset the group using keypad code: [User PIN] *, 6, 8, # or Perimeter Patrol's "Reset All" this will allow both keypads to be recognised by all energisers in the group.
10. If using a PTE0210 keypad, enter the key sequence *, 6, 8, # to automatically re-scan the group and check what energisers are connected.
11. Arm the group using keypad 1, 2, 3, 4, *, 1, 0, #, or by using Perimeter Patrol. Make sure all Energisers are activated.

Note:

1. Members of a group can be individually switched on and off; even the master can be turned off via input or key switch.
2. A slave will generate a General alarm if the keypad bus is broken between it and the group master.
3. After programming the Keypad may be disconnected, it is not required for group operation.
4. When connected to Perimeter Patrol, the arm/disarm function of a keypad is disabled. Control of these functions is through the Perimeter

Patrol interface.

- 5. A Keypad that is connected to a Slave Energiser that is disconnected from the Group, must have a KEYPAD ADDRESS set to 1.



Electric Fencing Products



DEALER



WWW.JVA-FENCE.COM