



# JVA Perimeter Patrol Installation and Configuration Manual

Version: 6 Revision 1  
Date: March 2019

The screenshot displays the JVA Perimeter Patrol Pro software interface. It features several windows:

- JVA Event Log:** A table showing recent events. The top three events are highlighted in red, indicating active or critical alerts.
- QuickView:** A summary panel showing the current status of the perimeter sectors.
- Site Map:** A 3D-style map of the facility with four sectors labeled: North sector, East sector, West sector, and South sector. The East sector is highlighted in red, indicating an alarm.
- Please Authenticate [Local]:** A dialog box requiring user credentials to perform an action.

Event ID	Time of First Occurrence	Username	Zone	Description	Time Muted	Muted By	Occurrences	Time of Latest Occurrence
2597	5/03/2013 10:58	Administr...	East se...	FENCE ALARM			3	5/03/2013 11:53 AM
2598	5/03/2013 10:58	Administr...	East se...	UNDER VOLTAGE (Return)			2	5/03/2013 11:54 AM
2599	5/03/2013 10:58	Administr...	East se...	UNDER VOLTAGE (Feed)			2	5/03/2013 11:54 AM
2626	5/03/2013 11:51	Administr...	East se...	OVER VOLTAGE (Return)			1	
2627	5/03/2013 11:51	Administr...	East se...	OVER VOLTAGE (Feed)			1	

Zone	kV
North sector	6.3
East sector	2.8
South sector (kV)	4.5
West sector	4.8

Tip: To move a zone label, hold down 'Shift' and drag the label to the required position.

HL1 0 Clients | Coms: OK (1 Ethernet) | Database: OK | ADMINISTRATOR:Administrator

Clear Alarm Memory | Mute Active Alarms

Legend: Disarmed Armed Activated Alarmed

## Table of Contents

1 Introduction .....	4
1.1 Scope and purpose .....	4
1.2 Other relevant documentation.....	4
1.3 JVA Perimeter Patrol .....	5
2 Wiring and architecture considerations for connecting JVA Perimeter Patrol to JVA Security Electric Fence Devices .....	7
2.1 Introducing the Keypad Bus.....	7
2.2 Group Mode configuration .....	7
2.2.1 Keypad Bus Limitations.....	8
2.3 Wiring overview .....	8
2.3.1 Serial connection.....	9
2.3.2 Ethernet connection .....	10
2.3.3 Devices that connect the computer to the Keypad Bus.....	12
2.4 Wiring limitations and best practices.....	13
2.5 Using an Ethernet adapter .....	14
2.5.1 Wiring the Ethernet adapter .....	14
2.5.2 Configuring Devices for operation with the Ethernet adapter.....	15
2.5.3 Debugging an Ethernet adapter .....	15
3 Installing JVA Perimeter Patrol software .....	18
3.1 System requirements.....	18
3.1.1 Connectivity .....	18
3.1.2 Security.....	18
3.1.3 Serial Port .....	18
3.1.4 Ethernet Port.....	18
3.2 Uninstalling older versions.....	19
3.3 Installing JVA Perimeter Patrol .....	19
3.3.1 Install Prerequisites.....	19
3.3.2 Install JVA Perimeter Patrol .....	20
4 Activating JVA Perimeter Patrol .....	22
4.1 Activating with a Coupon .....	22
4.2 Migrating a License from one computer to another .....	24
4.3 Activating Manually.....	25
4.4 Activating with the 30 day demo licence .....	27
4.5 Logging into Perimeter Patrol Pro.....	28

4.6 Changing the Administrator password .....	29
4.7 Configuring user accounts .....	30
4.7.1 Enabling and disabling user accounts .....	30
4.7.2 Promoting and demoting users.....	30
4.7.3 Summary of user access permissions .....	30
4.7.4 Configuring full screen mode.....	31
4.8 Configuring alarms and email .....	32
4.8.1 Alarm Delay Settings.....	34
4.8.2 Alarm Popup Timeout.....	34
5 Configuring the Site.....	37
5.1 Connect using Serial Communications (RS232 or USB).....	37
5.1.1 Scanning to detect zones .....	37
5.1.2 Understanding detected zones.....	38
5.1.3 Adding and configuring zones .....	38
5.1.4 Other zone configuration utilities .....	38
5.2 Connecting to an Ethernet Adapter (Local Area Network).....	39
5.2.1 Connecting.....	39
5.2.2 WinPcap Error Message .....	40
5.2.3 Scanning for devices and zones.....	41
5.2.4 Ethernet Adapter Descriptor .....	42
5.2.5 Configuring an Ethernet Adapter .....	43
5.2.6 Adding electric fence zones to JVA Perimeter Patrol.....	45
5.3 Configuring Zone Settings .....	48
5.3.1 Setting Longitude and Latitude.....	48
5.4 Setting the control schedule for a zone .....	50
5.5 Selecting Map Image .....	51
5.5.1 Selecting the Map .....	51
5.5.2 Setting the Zoom Level for the Map.....	52
5.5.3 Setting the line thickness and start markers .....	52
5.6 Drawing zones on the map .....	53
6 Configuring Advanced Features .....	55
6.1 Configuring IO Boards with JVA Perimeter Patrol .....	55
6.1.1 Configuring Analog Inputs .....	56
6.1.2 Configuring Digital Inputs .....	57
6.1.3 Digital Input Functions.....	58
6.1.4 Configuring Outputs .....	59

6.1.5 Output Function Descriptions .....	60
6.2 Zone/Sector/Input/Output Colours .....	61
6.3 Alarm Popups .....	62
6.4 Custom URL (Hyperlink) Buttons .....	63
6.5 Map Icons.....	63
7 Connecting two instances of Perimeter Patrol in Server / Client configuration using the HLI .....	65
7.1 Configuring Perimeter Patrol Server .....	65
7.1.1 Configuring Perimeter Patrol Server to accept HLI connections .....	65
7.2 Configuring Perimeter Patrol Client.....	66
7.3 Using the correct IP Address and Port.....	68
7.3.1 Connecting Server and Client on LAN.....	69
7.3.2 Connecting Server and Client on WAN .....	70
8 Locking down the computer to keep JVA Perimeter Patrol secure .....	71

## 1 Introduction

**JVA Perimeter Patrol**, a software system for monitoring and commanding JVA Security Electric Fence Devices, is designed exclusively for **JVA Technologies Pty Ltd** by **Pakton Technologies Pty Ltd** of Brisbane, Australia.

Keep this document secure.

### 1.1 Scope and purpose

This installation and configuration manual is an OEM manual for use by JVA Security System Installers and Administrators. It covers:

- Wiring and architecture considerations for connecting JVA Perimeter Patrol to JVA Security Electric Fence Devices
- Installation and configuration of JVA Perimeter Patrol
- Connecting instances of JVA Perimeter Patrol together in Server / Client configuration
- Locking down a computer to keep JVA Perimeter Patrol secure

### 1.2 Other relevant documentation

Read this document in conjunction with these other documents:

- **JVA Perimeter Patrol User Manual**
  - User manual for every-day operation of JVA Perimeter Patrol
- **JVA Perimeter Patrol High Level Interface Programmers Guide**
  - Programmers' guide for using a HLI to connect to Perimeter Patrol from their own custom software
- **Z Series OEM Technical Manual**
  - Installation and configuration instructions for the Z-series range of JVA Security Electric Fence energisers
- **ZM1 OEM Technical Manual**
  - Installation and configuration instructions for the **JVA ZM1 Security Electric Fence Zone Monitor**
- **ZM20 OEM Technical Manual**
  - Installation and configuration instructions for the **JVA ZM20 Security Electric Fence Zone Monitor**
- **Ethernet Adapter Manual**
  - Installation and configuration instructions for the **PAE212 Perimeter Patrol Interface Board**
- **General Purpose IO Technical Manual**
  - Installation and configuration instructions for the **PAE222 General Purpose IO Board**
- **Ethernet General Purpose IO Technical Manual**
  - Installation and configuration instructions for the **PAE224 Ethernet GPIO Board**

### 1.3 JVA Perimeter Patrol

Perimeter Patrol provides PC based supervisory control and logging for Pakton designed security electric fence energisers and monitoring systems. A powerful, flexible and intuitive user interface is provided over a stable industry standard database structure.

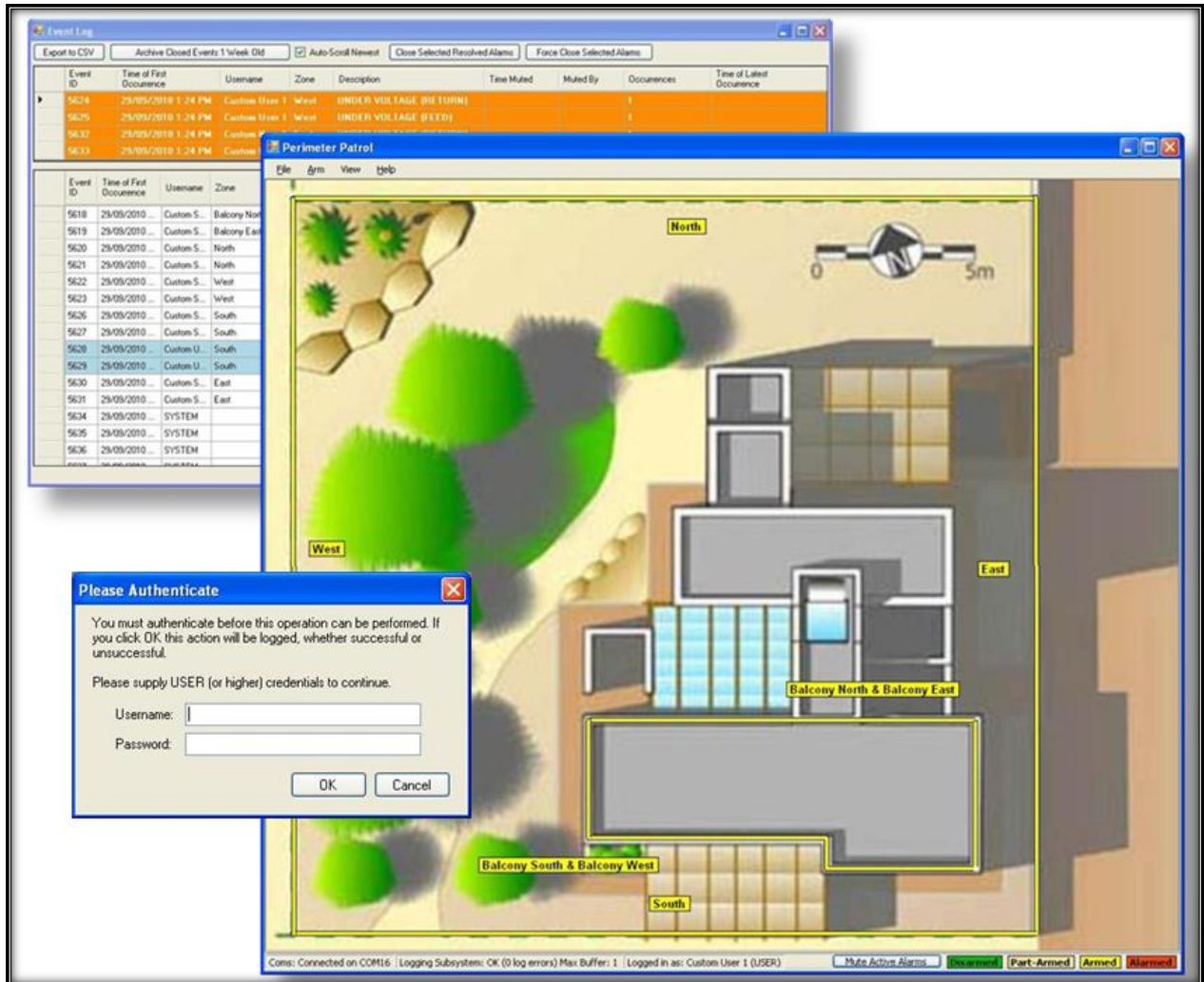

Figure 1 - Screenshots of JVA Perimeter Patrol

<b>JVA Perimeter Patrol Features</b>	Lite	Pro
View & Control Energiser Zones	✓	✓
View & Control Zone Monitors	-	✓
Support Multiple Sectors Per Zone	-	✓
Map-Oriented Zone Mimic Screen	✓	✓
Automatically Control on Schedule	✓	✓
Alarm Display and Sound	✓	✓
Email on Alarm	✓	✓
Log alarms and events	-	✓
Automatically Control Output Relays in Response to Alarms	-	✓
User control output relays	-	✓
Serial Communication Mode	✓	✓
Ethernet (TCP/IP) Communication Mode	-	✓
User Authentication	-	✓
Full Screen Mode Preventing Access to Other Applications	-	✓
Event Logging with Viewer and Automatic Archival	-	✓
Administrator's Full System Controller	-	✓
Integrate other equipment via contact inputs and relay outputs	-	✓
High Level Interface API	-	✓
Cloud Backup – Backup settings to the cloud	-	✓

### **JVA Perimeter Patrol Specifications**

Operating System	Microsoft Windows 7 / 8 / 10	
Logging Database (Not available in Mimic or Lite)	Microsoft SQL Server Compact Edition	
Communications Interface	TCP/IP or Serial Port (USB or built-in)	
Minimum CPU	Intel or compatible Pentium III 1 GHz or faster	
Minimum RAM	4GB	
Scheduled Control	Repeats:	Weekly
	Granularity:	30 Minutes
Email Support	SMTP, SSL, Authentication	
Maximum Number of Zones	Lite	30
	Pro	Up to 1778 (limit depends on system configuration)
User Levels (not available in Mimic or Lite)	User	View zone voltages and alarms
	Supervisor	<i>All User tasks above</i> Control energisers Close resolved alarms Exit Full Screen Mode
	Administrator	<i>All Supervisor tasks above</i> Modify System Configuration
Integration of Legacy Equipment	Via contact input and relay outputs	

## 2 Wiring and architecture considerations for connecting JVA Perimeter Patrol to JVA Security Electric Fence Devices

### 2.1 Introducing the Keypad Bus

JVA Perimeter Patrol monitors and commands the following JVA Security Electric Fence Devices:

Table 1- List of JVA Security Electric Fence Devices

Security Electric Fence Device	Purpose
<b>Electric Fence Energiser</b>	To power and monitor zones. A zone is an individual section of electric fence. A zone can be armed or disarmed without affecting other zones. Alarms are raised for individual zones.
<b>Zone Monitor</b>	To monitor a zone that is being powered by another energiser.
<b>Ethernet Adapter</b>	To provide a bridge between the Keypad Bus and the Local Area Network, allowing Perimeter Patrol to connect to the Keypad Bus via Ethernet.
<b>IO Board</b>	To provide extension inputs and outputs. Inputs accept signals from non-JVA security devices such as motion sensors or gate sensors. Outputs provide a way to send signals to external systems such as sirens, strobes, alarms, watchdog monitors, pumps, gates etc.
<b>Ethernet IO Board</b>	Combines the function of both the Ethernet Adapter and the IO Board, with the addition of analog input capabilities.
<b>Keypad</b>	To allow security personnel to perform manual configuration or command of JVA devices.

Each of the JVA security electric fence devices listed above communicate on a serial data bus that has been given the name **Keypad Bus**, mostly because it allows the keypad to connect to the devices.

### 2.2 Group Mode configuration

Each device on a Keypad Bus must be configured with a unique id that identifies it on that Keypad Bus. That unique id is called the **Keypad Bus Id** and it ranges in value from 1 to 15. When you are installing the devices, you must first connect a keypad directly to the device to set its configuration properties before you connect it to the Keypad Bus with all the other devices attached.

The device configured with Keypad Bus Id = 1 becomes the **Master** device, which is responsible for marshalling communications between all the devices on the Keypad Bus, and for synchronizing the timing of all energisers on the Keypad Bus.

Devices configured with Keypad Bus Id = 2 – 15 become **Slave** devices.

In the user manuals for each device, the device's Keypad Bus Id will be referred to as its **Group Mode**. You configure the Keypad Bus Id for each device by settings its Group Mode configuration property.



Refer to each device's user manual to find out how to set its Group Mode configuration property.

After you have used a keypad to configure each device individually, you may connect all the devices together on the Keypad Bus.

### 2.2.1 Keypad Bus Limitations

Device	Maximum number of devices
LCD Keypads	2
Devices with a Keypad Bus Id	15

Devices with a Keypad Bus Id include energisers, zone monitors, Ethernet adapters, IO boards and Ethernet IO boards.

Note that LCD Keypads must each be configured with their own **Keypad Id** when attaching more than one to a Keypad Bus, but **Keypad Id** is independent of the **Keypad Bus Id** of other devices. Refer to the LCD Keypad's user manual for more information.

## 2.3 Wiring overview

The Keypad Data bus consists of three wires: Ground (GND), Data (DAT), and Power (+12V).

Energisers, Zone Monitors and Ethernet IO Boards supply power to the +12V wire while all other devices consume power from the +12V wire. The maximum number of devices excluding keypads that can be connected to a Keypad Data Bus is 15.

The computer that hosts JVA Perimeter Patrol can connect to the JVA Security Electric Fence Devices using serial communications or Ethernet communications over the Local Area Network. The sections below will help you decide which connection configuration you should choose.

**2.3.1 Serial connection**

The image below illustrates a possible wiring scenario for connecting JVA Perimeter Patrol to the Keypad Data Bus using either of the two serial communications systems available. The “Keypad Bus to Serial Converter” device illustrated could be either the **PAE051 Keypad Bus to RS232 Converter** or the **PAE223 Keypad Bus to USB Converter**.

Notice that one of the Energisers or Zone Monitors is configured with its **Group Mode Setting = Master** and all other devices are configured with **Group Mode Setting = Slave**.

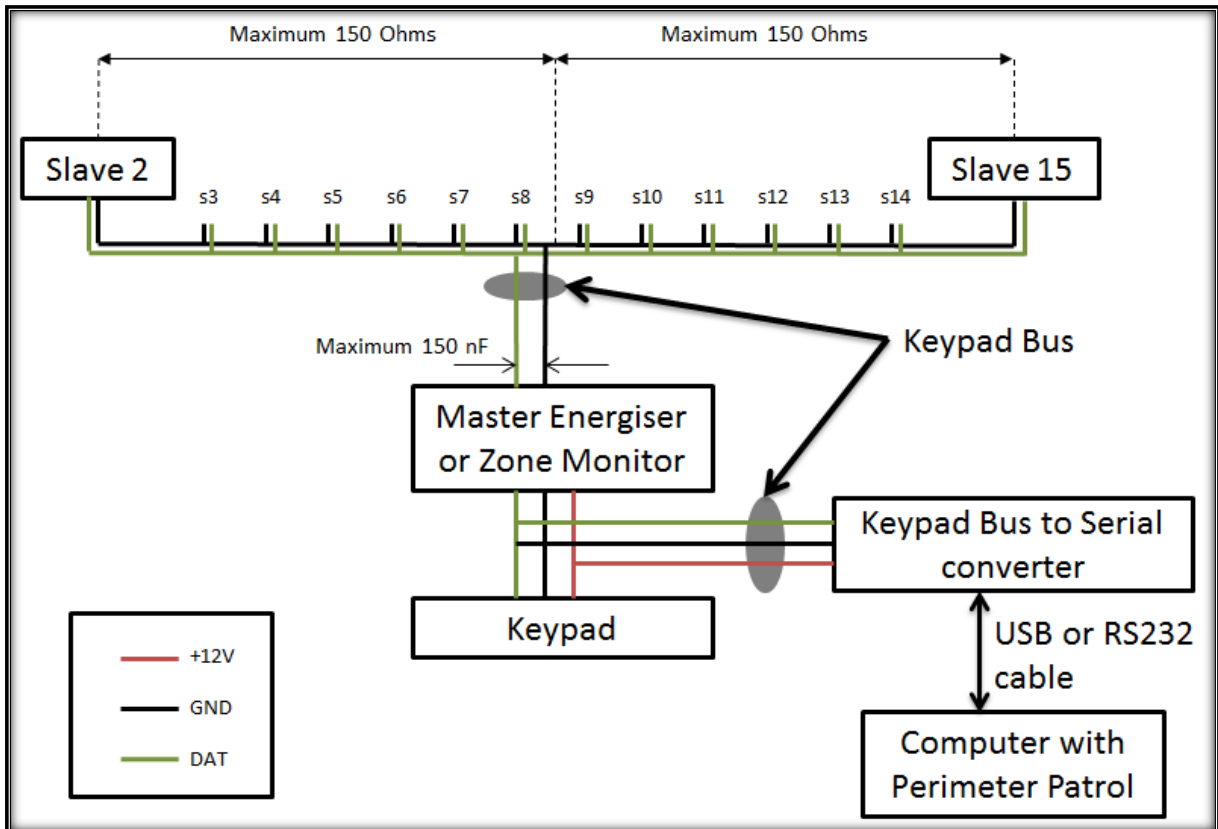

Figure 2 - Keypad Bus shown using PAE051/PAE223 converters to connect to JVA Perimeter Patrol using RS232/USB cable

**2.3.2 Ethernet connection**

The image below illustrates a possible wiring scenario for connecting JVA Perimeter Patrol to the Keypad Data Bus via the Local Area Network using either of the Ethernet adapters available. The “Master Ethernet Device” illustrated could be either the **PAE212 Ethernet Adapter Device** or the **PAE224 Ethernet IO Board**.

Notice that the Master Ethernet Device is configured with its **Group Mode Setting = Master** and all other devices are configured with **Group Mode Setting = Slave**.

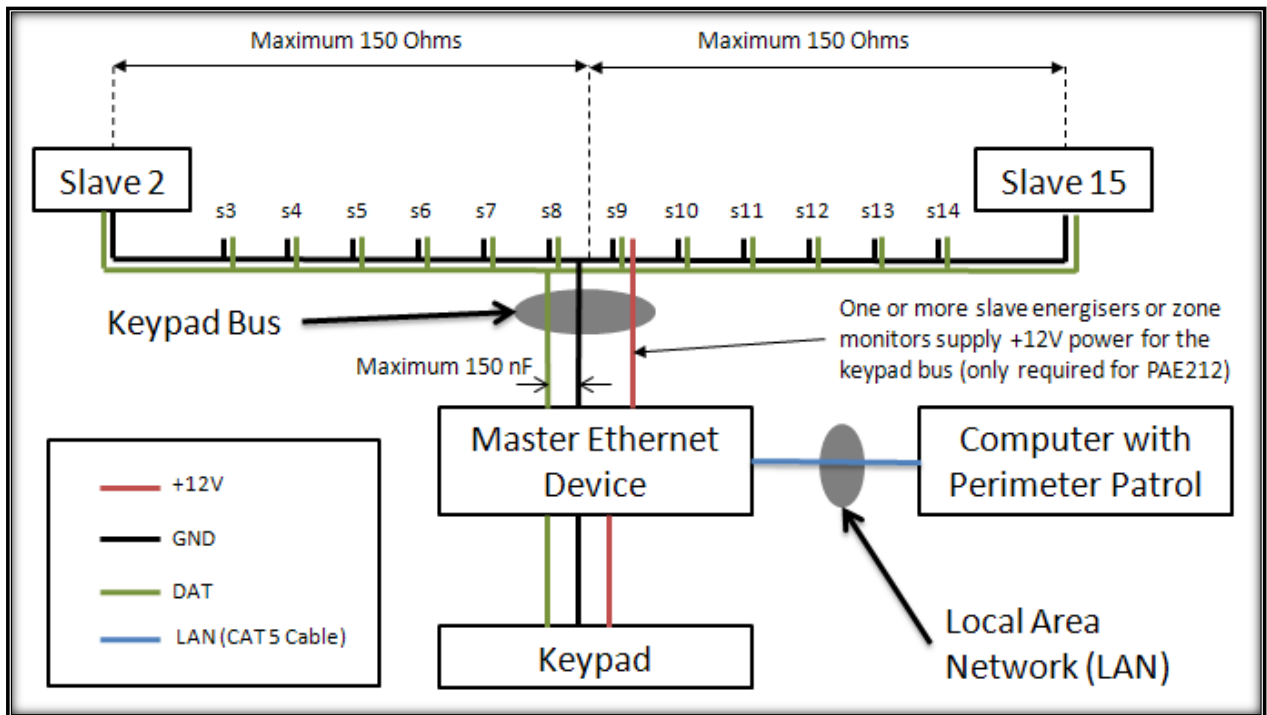

Figure 3 - Keypad bus shown using PAE212/PAE224 Ethernet boards to connect to JVA Perimeter Patrol using the Local Area Network

The Local Area Network can be used to connect multiple PAE212 Ethernet Adapter Devices and/or PAE224 Ethernet IO Boards to JVA Perimeter Patrol. This provides JVA Perimeter Patrol with the ability to monitor and command multiple groups of Security Electric Fence devices.

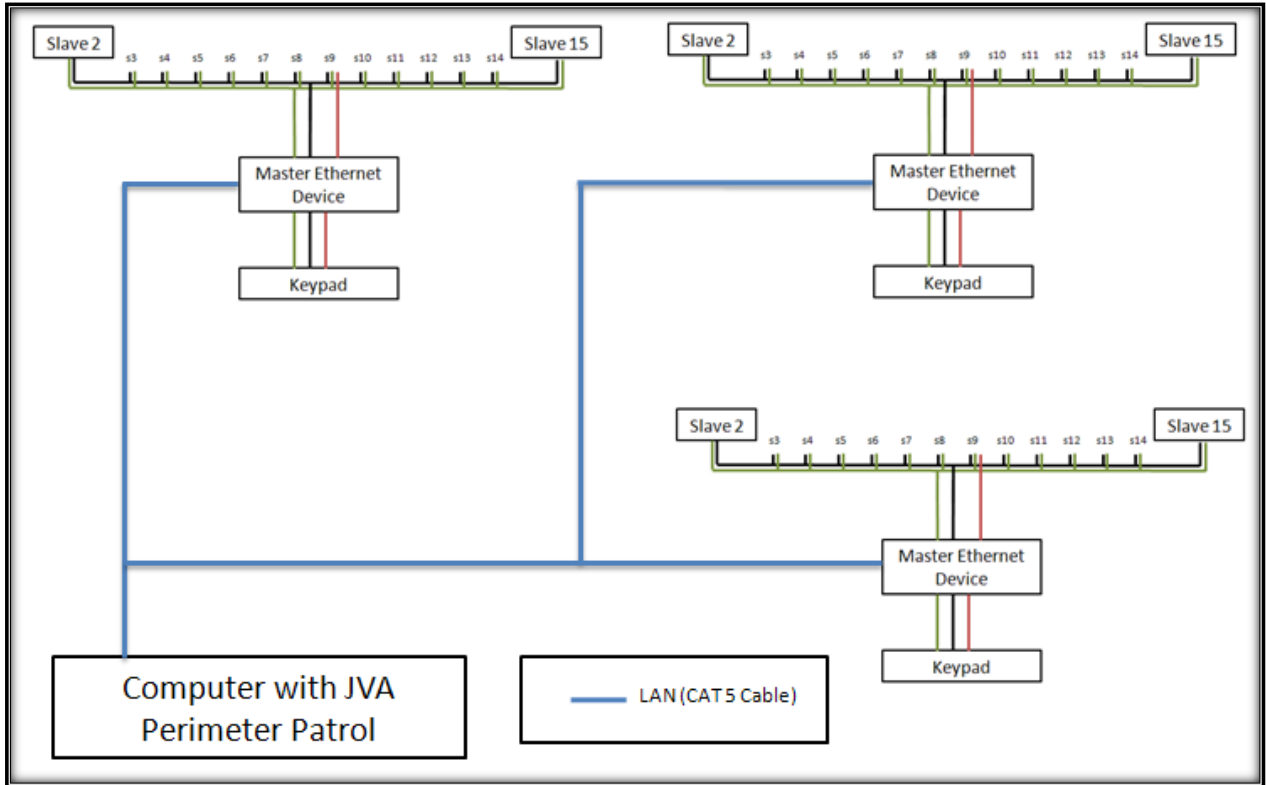

Figure 4 - Using the Local Area Network (LAN) to connect JVA Perimeter Patrol to multiple groups of JVA Security Electric Fence devices

### 2.3.3 Devices that connect the computer to the Keypad Bus

#### Local Area Network (LAN)



Device:  
PAE212 Ethernet Adapter Device

Comments:  
JVA Perimeter Patrol can be connected to multiple groups of Security Electric Fence devices.

Supports IO Boards

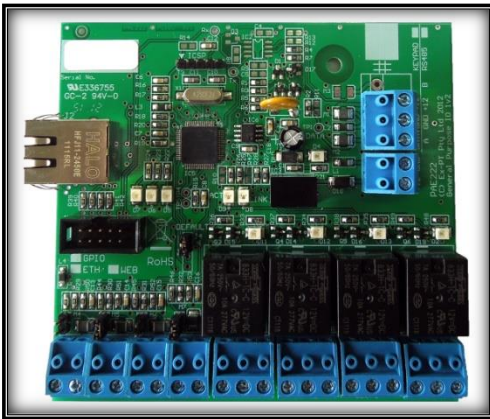

Device:  
PAE224 Ethernet IO Board

Comments:  
JVA Perimeter Patrol can be connected to multiple groups of Security Electric Fence devices.

Supports IO Boards

#### Serial Port using USB

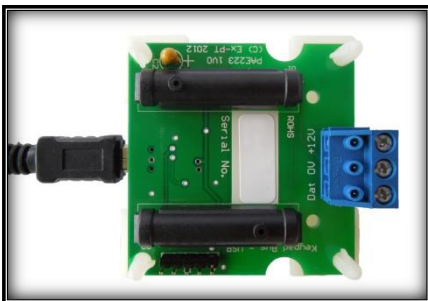

Device:  
PAE223 Keypad Bus to USB Converter

Comments:  
JVA Perimeter Patrol can only be connected to one of these devices, and therefore can only be connected to one group of Security Electric fence devices.

Supports IO Boards

#### Serial Port using RS232

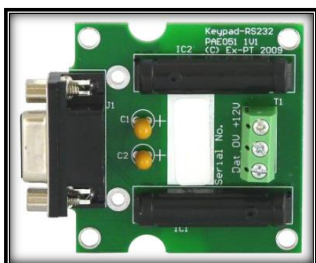

Device:  
PAE051 Keypad Bus to RS232 Converter

Comments:  
JVA Perimeter Patrol can only be connected to one of these devices, and therefore can only be connected to one group of Security Electric fence devices.

Supports IO Boards

### 2.4 Wiring limitations and best practices

For best results, the Master device should be connected closest to the control / monitoring unit (Keypad, computer or LCD display).

Maximum resistance from the keypad to the Master device on the GND wire or the DATA wire is 4.5 Ohm. Maximum resistance from the Master device to any other device on the GND wire or the DATA wire is 150 Ohms, maximum capacitance allowed between the GND and DATA wires measured at the Master device is 150nF

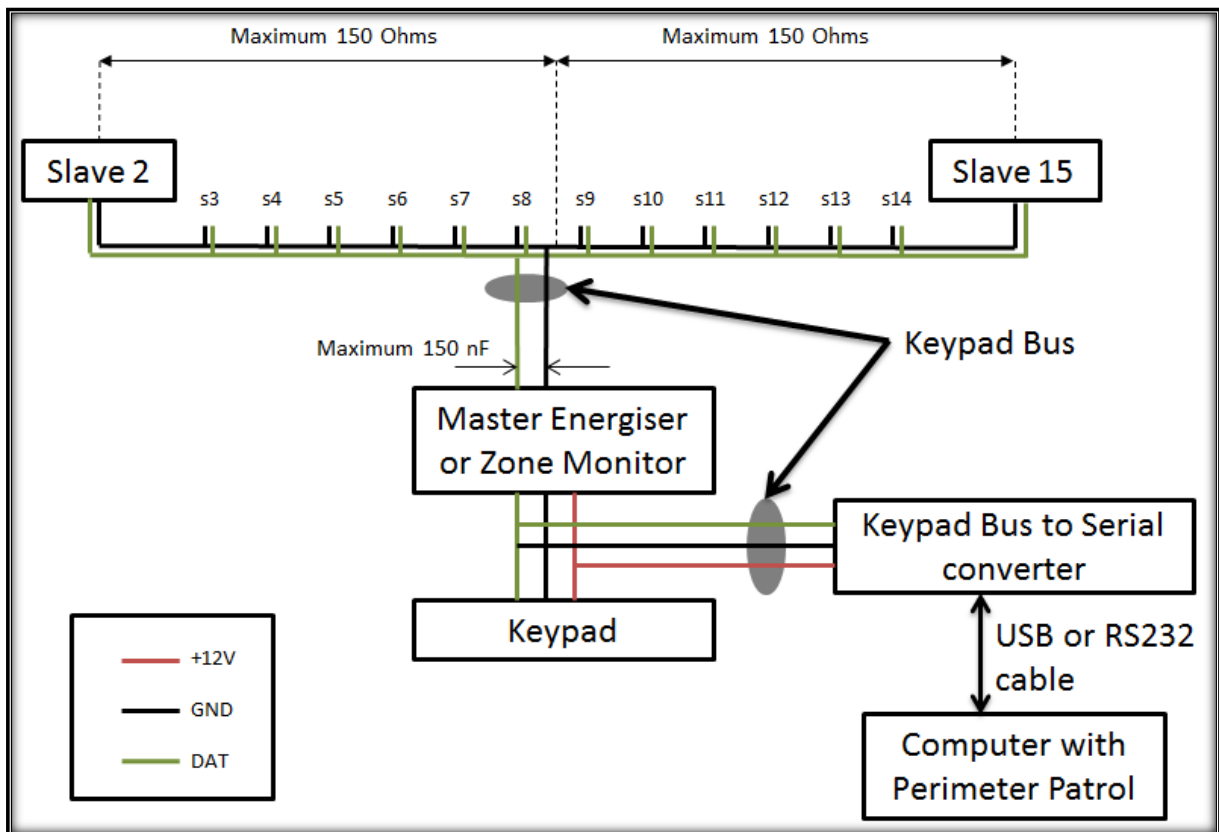

Figure 5 – Connecting a PAE051/PAE223 to JVA Perimeter Patrol via RS232 or USB cable

**Tip! “Two wires as one” technique:** If you are using CAT 5 cable for the Keypad Bus, you will have enough spare wires in the cable to use this clever trick for halving their resistance: Join together two wires at both ends to have them act together as a single wire. Make sure you join them together as they enter and exit each device.

**Note:** CAT 5 DC loop resistance is 0.188 Ohm / meter or 0.094 Ohm / meter if you are using the “two wires as one” technique.

It is worth measuring the capacitance between these two wires at the Master to make sure it doesn’t exceed this value. Based on this limitation, we recommend that the maximum length of cable be 1.5km.

If you are using 3 or more energisers, the Master device should be in centre of the cable and the energisers should be evenly spaced. Star or Ring Network configurations can be used and are recommended for large installations.

## 2.5 Using an Ethernet adapter

If you are using the Local Area Network to connect JVA Perimeter Patrol to the JVA Security Electric Fence Devices, you will need to use either the PAE212 Ethernet Adapter Device or the PAE224 Ethernet IO Board.

### 2.5.1 Wiring the Ethernet adapter

#### PAE212

- Wire the Keypad Bus into the adapter (+12V, GND, DAT).
  - Energisers, Zone Monitors, and Ethernet IO Boards **supply** power to the Keypad Bus.
  - All other devices **consume** power from the Keypad Bus.
- Connect the Ethernet port of the PAE212 to the building Local Area Network (LAN)

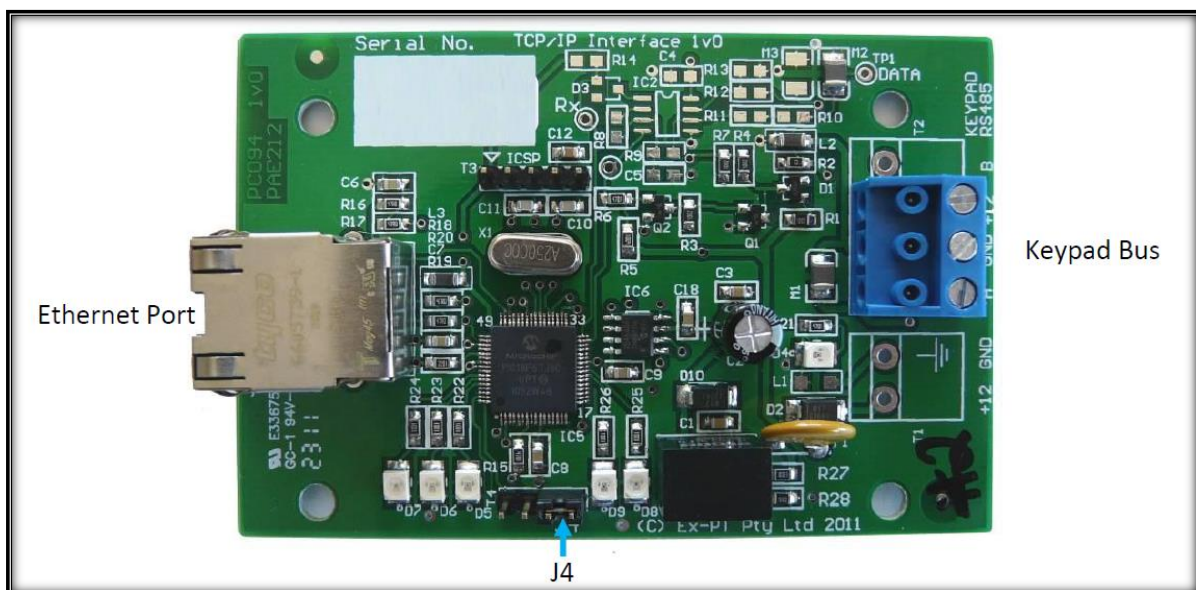

Figure 6 - PAE212 Ethernet Adapter Device



**PAE224**

- Wire Power into the adapter (+12V, GND).
- Wire the Keypad Bus into the adapter (DAT, GND). Only wire +12V if the PAE224 is used to directly power a keypad.
- Connect the Ethernet port of the PAE224 to the building Local Area Network (LAN)

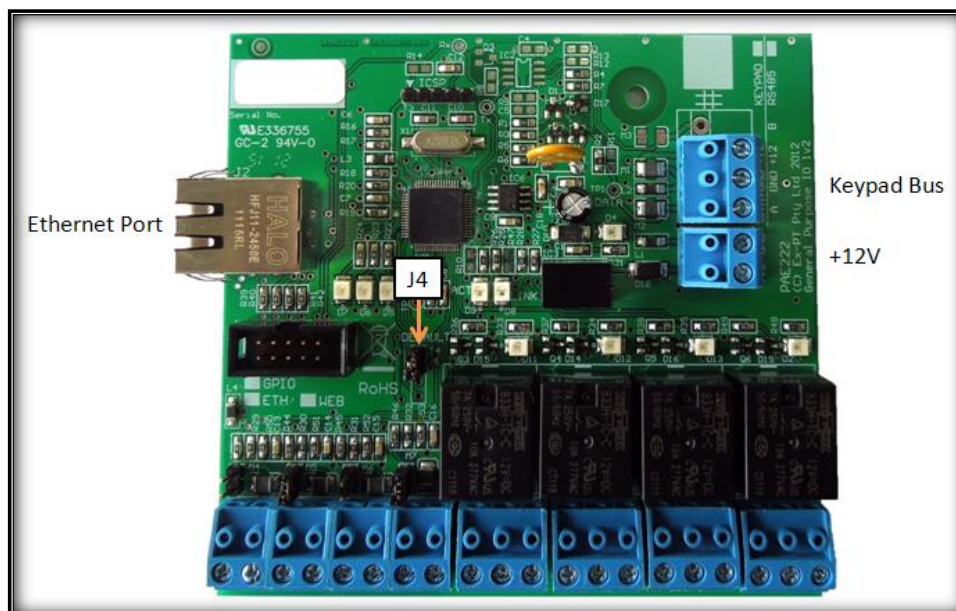

Figure 7 - PAE224 Ethernet IO Board

### 2.5.2 Configuring Devices for operation with the Ethernet adapter

The PAE212 Ethernet Adapter Device and PAE224 Ethernet IO Board are configured with their Group Mode property = 1, which means it is the Master Device and has a Keypad Bus Id = 1.

Therefore all other devices must have their Group Mode set to a value between 2 and 15, which will configure them to be slaves.

Remember, no two devices can have the same Keypad Bus Id.

### 2.5.3 Debugging an Ethernet adapter

#### 2.5.3.1 Return to Factory Defaults (Jumper J4)

If for some reason the PAE212 Ethernet Adapter Device or PAE224 Ethernet IO Board is not recognised by Perimeter Patrol, or it is not working as expected, it may be beneficial to return it to Factory Defaults. To do so:

- Remove the black jumper located at J4 (see previous images for jumper location).
- Depower the Ethernet adapter by removing the Power connector (PAE224 only) and the Keypad Bus connector.
- Repower the Ethernet adapter by re-attaching the Power connector (PAE224 only) and the Keypad Bus connector.



When the Power and Keypad Bus connection is returned, the LEDs D5 and D6 and D7 (see image below) will light for ½ a second. The D7 blink shows the board loading the Factory Defaults. Replace the jumper across both pins of J4.

**2.5.3.2 LED Indications for the Ethernet adapter**

LEDs on the PAE212 and PAE224 can be used to get valuable debugging information when you are installing or troubleshooting its operation. The position of each LED is shown in the images below, and the table following it explains the function of each LED.

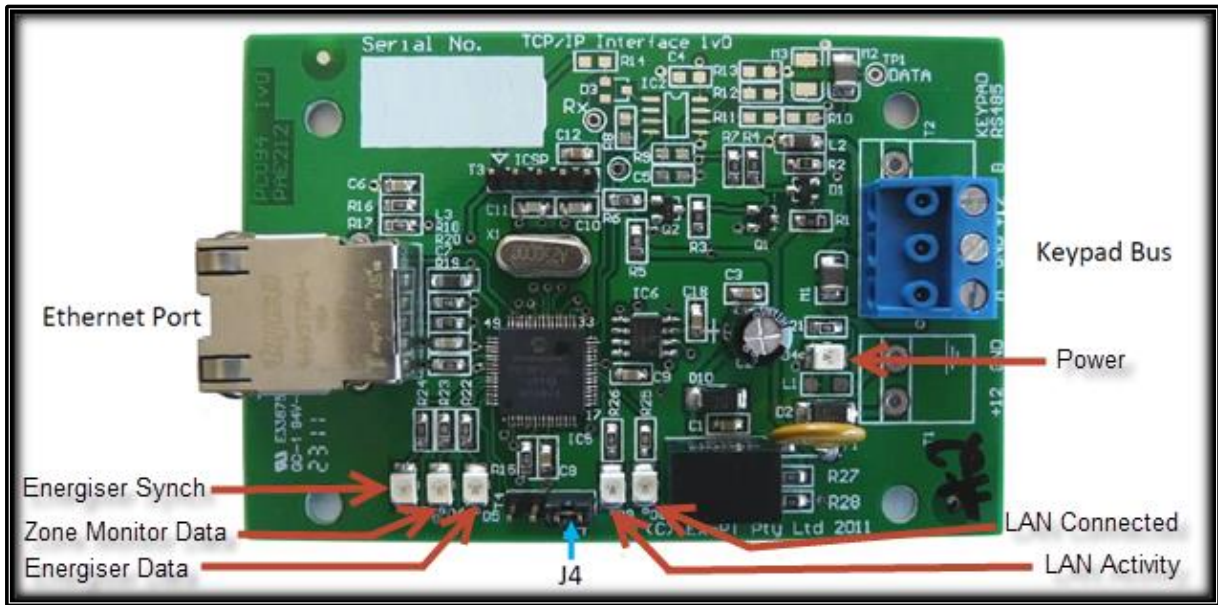

Figure 8 - LED Indications for the PAE212 Ethernet Adapter Device

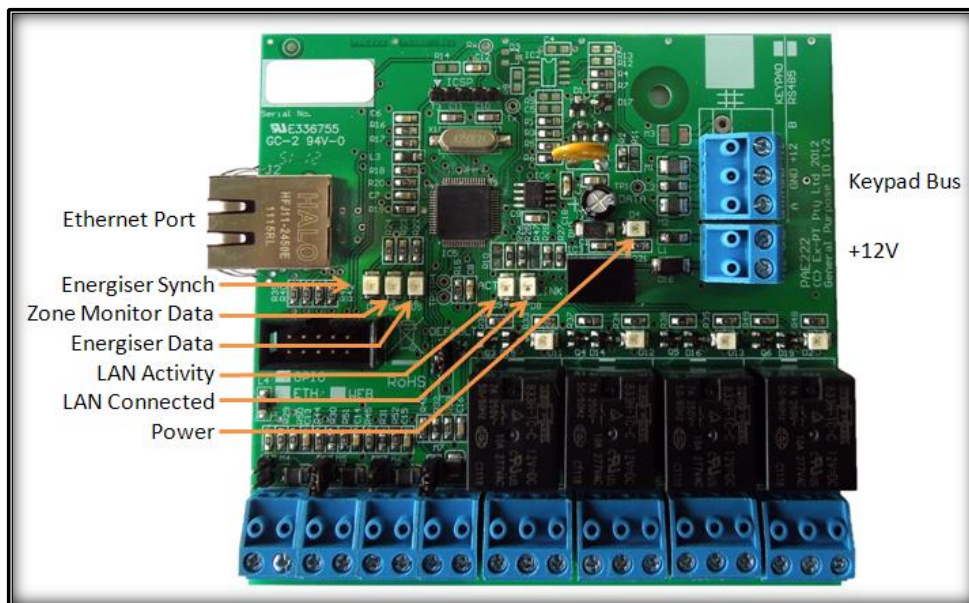

Figure 9 – LED Indications for the PAE224 Ethernet IO Board

**Table 2 - LED Functions for the PAE212 Ethernet Adapter Device**

<b>Name</b>	<b>ID</b>	<b>Colour</b>	<b>Function</b>
<b>Power</b>	D4	Green	ON when the Ethernet Device has power
<b>Energiser Synch</b>	D7	Red	Blink once per second when the energisers are synchronised
<b>Energiser Data</b>	D5	Red	Blinks rapidly (one blink per energiser) when receiving data from the energisers
<b>Zone Monitor Data</b>	D6	Red	Blinks rapidly (one blink per zone monitor) when receiving data from the zone monitors
<b>LAN Connected</b>	D8	Green	On when connected to the Local Area Network (LAN)
<b>LAN Activity</b>	D9	Green	Blinks when sending information to JVA Perimeter Patrol

## 3 Installing JVA Perimeter Patrol software

### 3.1 System requirements

Operating System	Microsoft Windows 7 / 8 / 10 <i>Do not use Windows Vista or any earlier versions of Windows</i>
CPU	Intel or compatible Pentium III 1GHz or faster. <i>Use the Windows Task Manager to make sure the CPU is using less than 5% of its capacity while JVA Perimeter Patrol is running.</i>
Hard Drive	120Gb with at least 50% free space <i>JVA Perimeter Patrol log files can grow to large sizes. Ensure your computer's hard drive is large enough to hold them.</i>
RAM	4GB <i>Use the Windows Task Manager to make sure there is at least 1GB of free RAM remaining after JVA Perimeter Patrol is running.</i>

#### 3.1.1 Connectivity

If you intend using the following features of JVA Perimeter Patrol, ensure that the host computer has a stable, active internet connection:

- Email
- High Level Interface (requires static IP Address)
- Cloud Backup

#### 3.1.2 Security

Lock down the computer according to section **Locking down the computer to keep JVA Perimeter Patrol secure** below.

#### 3.1.3 Serial Port

If you intend connecting to JVA Security Electric Fence devices using Serial Port or USB Port, ensure your computer has a spare port of the correct type available.

#### 3.1.4 Ethernet Port

If you intend connecting to JVA Security Electric Fence Devices using the Local Area Network, ensure your computer has an Ethernet port or wireless connection available for connecting to the required LAN.

### 3.2 Uninstalling older versions

Before installing JVA Perimeter Patrol on a computer, you should make sure that previous versions have been uninstalled first.

1. Go to **Control Panel** → **Programs and Features** and search for “Perimeter Patrol”.
2. Select any items that appear in the program list
3. Then click the **Uninstall** button.

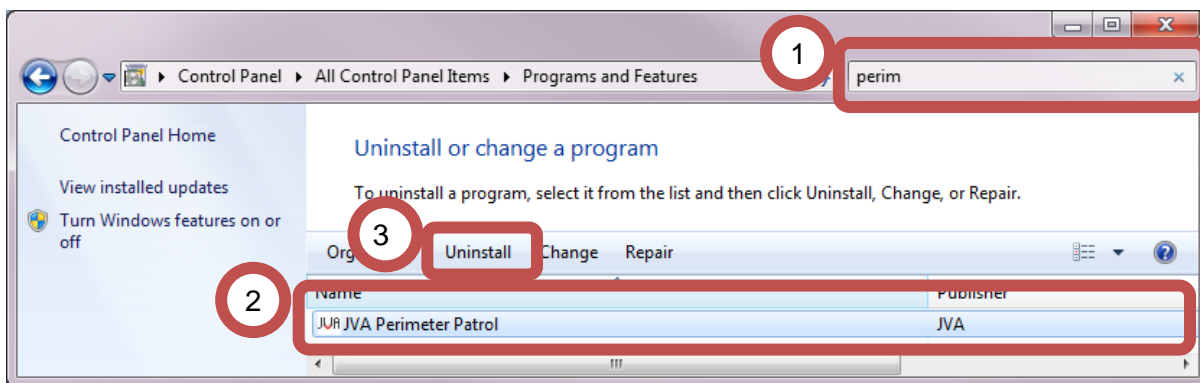

Figure 10 - Uninstalling JVA Perimeter Patrol

### 3.3 Installing JVA Perimeter Patrol

#### 3.3.1 Install Prerequisites

The first prerequisite you must install is WinPcap, a utility that helps Perimeter Patrol communicate with the Ethernet Adapter devices on the Local Area Network.

Using the installation CD you have been provided, open the Step 1 folder and select the Version of windows you are installing on. Run the file **WinPcap\_4\_1\_3.exe** to install WinPcap.

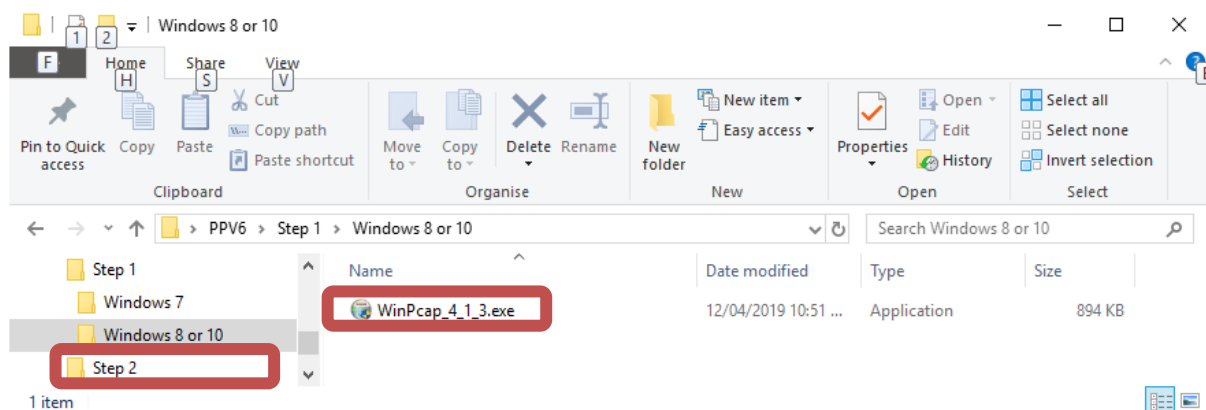

Figure 11 - Installing WinPcap

### 3.3.2 Install JVA Perimeter Patrol

Open Step 2 and run the **Setup.exe** install file. To ensure that the latest version is installed, please have a stable internet connection.

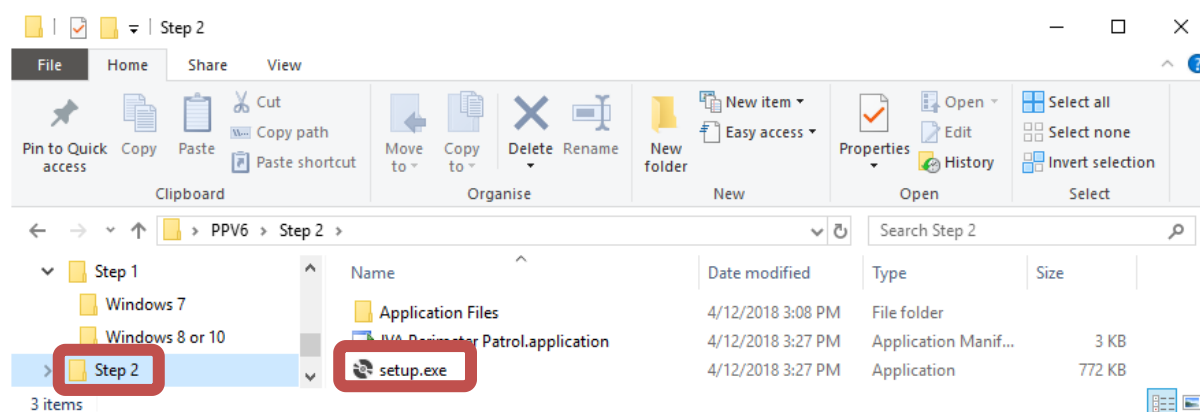

Figure 12 – Start the setup of Perimeter Patrol

You will be given a couple of security warnings that will need to be bypassed.

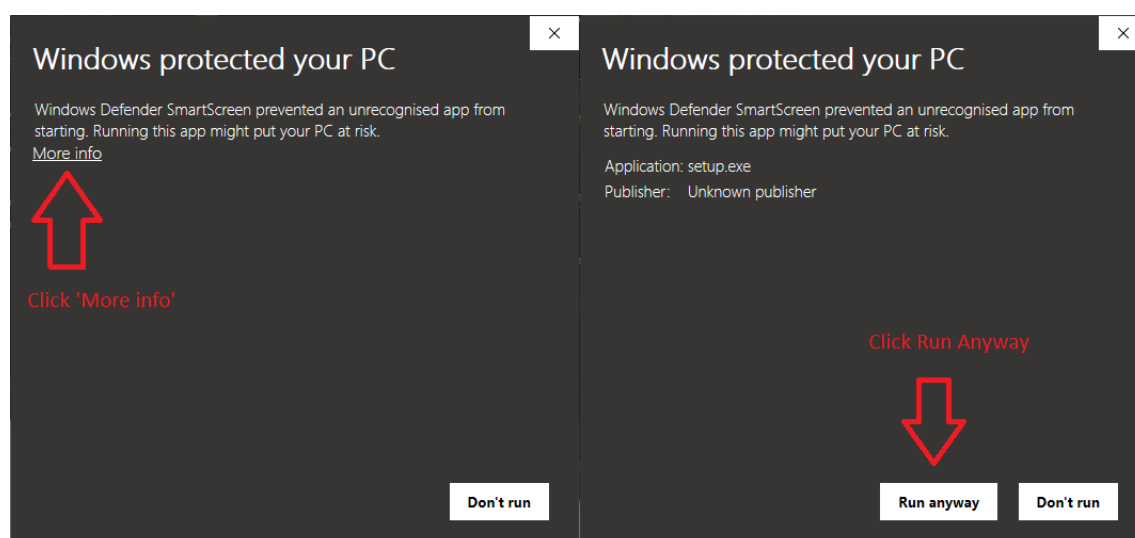

Figure 13 – Bypass the security warning

Following this you will need to install .NET Framework 4.7.2. If you already have this installed this prompt will not appear. After that you click install to finally install Perimeter Patrol.

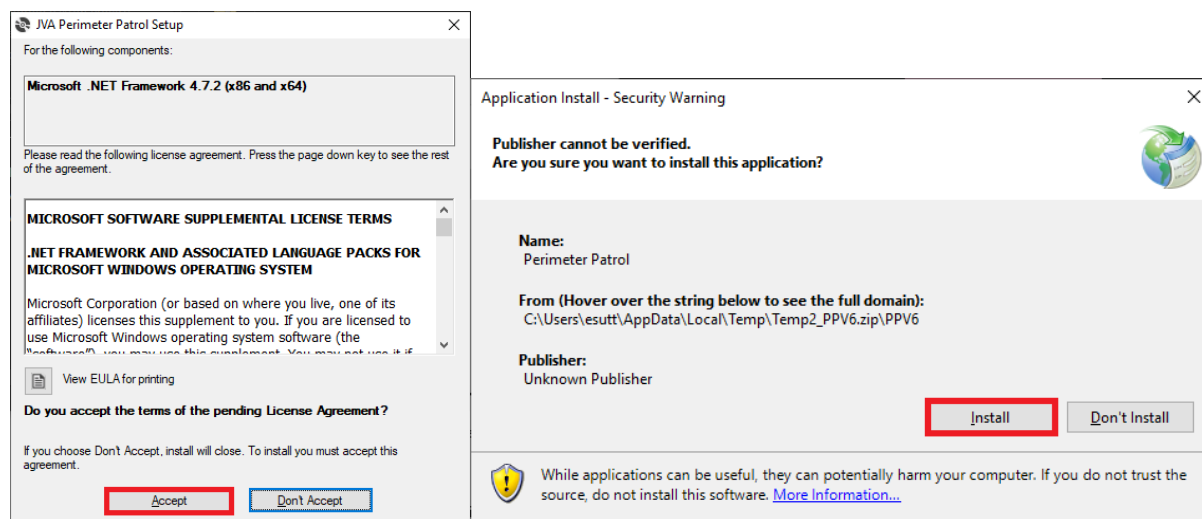

Figure 14 – install .NET Framework 4.7.2, then Install Perimeter Patrol itself

You can start JVA Perimeter Patrol by clicking its icon on your desktop or by searching for it in your Windows start menu. Below is a picture of how the JVA Perimeter Patrol icon may look on your computer’s desktop. To find it in your Windows start menu, click **Start -> All Programs -> JVA -> JVA Perimeter Patrol**.



Figure 15 - JVA Perimeter Patrol desktop icon

## 4 Activating JVA Perimeter Patrol

When you start JVA Perimeter Patrol, it will open immediately in Lite mode, which provides free, limited functionality. To enable the advanced features of JVA Perimeter Patrol the software will need to be activated.

### 4.1 Activating with a Coupon

1. Click **Setup** → **Licensing**
2. Select **Activate Perimeter using a coupon**
3. Enter your name
4. Enter your organization name
5. Enter the email address that you wish to receive a backup of the Activation Code for your own records
6. Enter the coupon
7. Click Submit

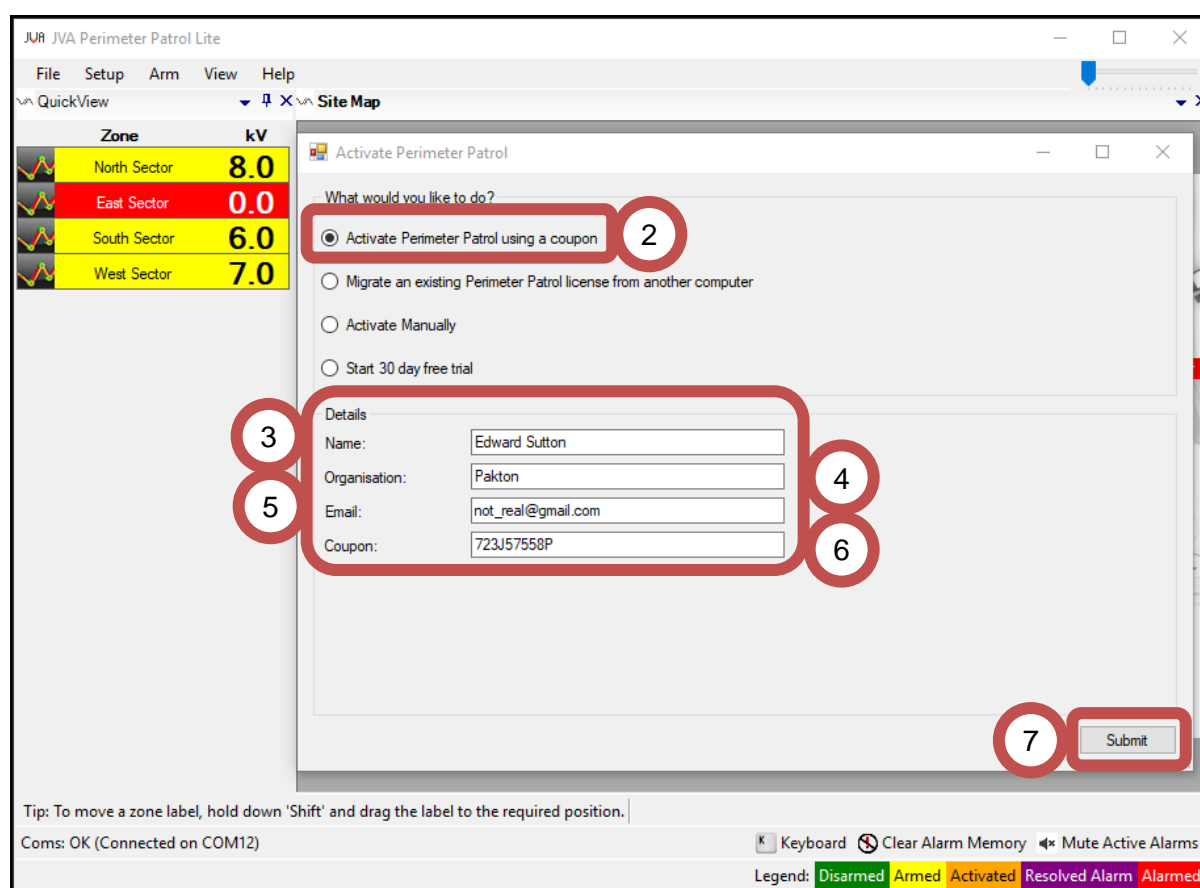

Figure 16 – Activating using a Coupon

You should receive an email as shown below. Keep this safe, as if you ever need to migrate from one computer to another, you will need to use this **Activation Code**.

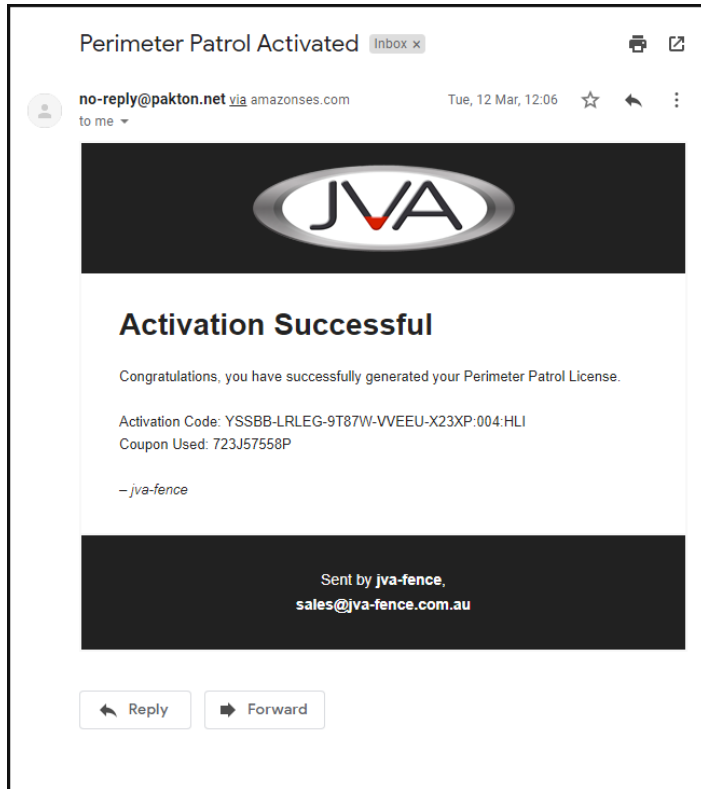

Figure 17 – Example email that you will receive once you have activated



### 4.2 Migrating a License from one computer to another

Under certain circumstances, you may wish to move an installation from one computer to another. Note, you cannot upgrade from a version 5 license to a version 6 license using this technique. For that you will need to purchase a new license.

1. Click **Setup → Licensing**
2. Select **Migrate an existing Perimeter Patrol license from another computer**
3. Enter your name
4. Enter your organization name
5. Enter the email address that you wish to receive a backup of the Activation Code for your own records
6. Enter the **Activation Code** from the previous installation. This will have been sent to your email address from a previous activation.
7. Click **Submit**

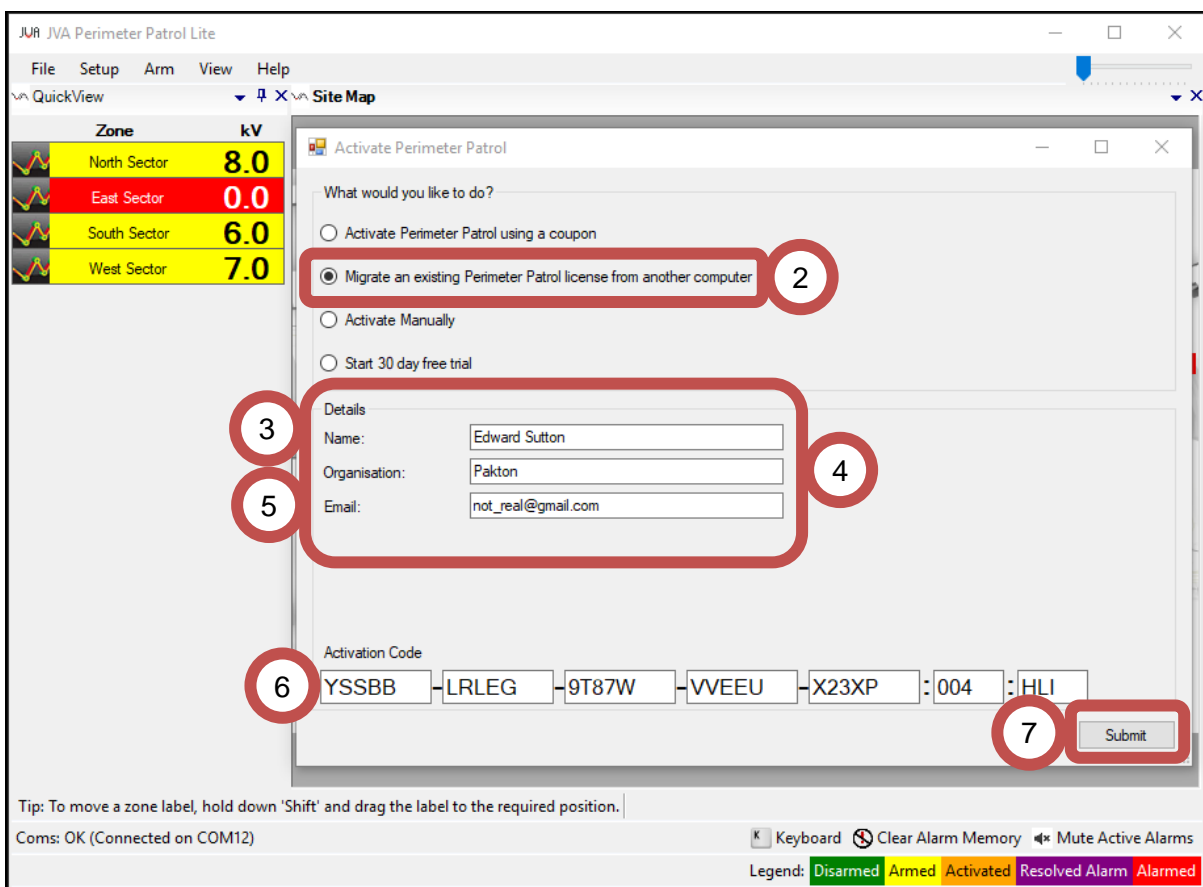

Figure 18 – Migrating an existing Perimeter Patrol license from one computer to another

### 4.3 Activating Manually

If you have deactivated Perimeter Patrol for some reason and just need to reactivate using your existing **Activation Code** then you can use the following approach.

1. Click **Setup → Licensing**
2. Select **Activate Manually**
3. Enter your name
4. Enter your organization name
5. Enter the **Activation Code** from the previous installation. This will have been sent to your email address from a previous activation.
6. Click Submit

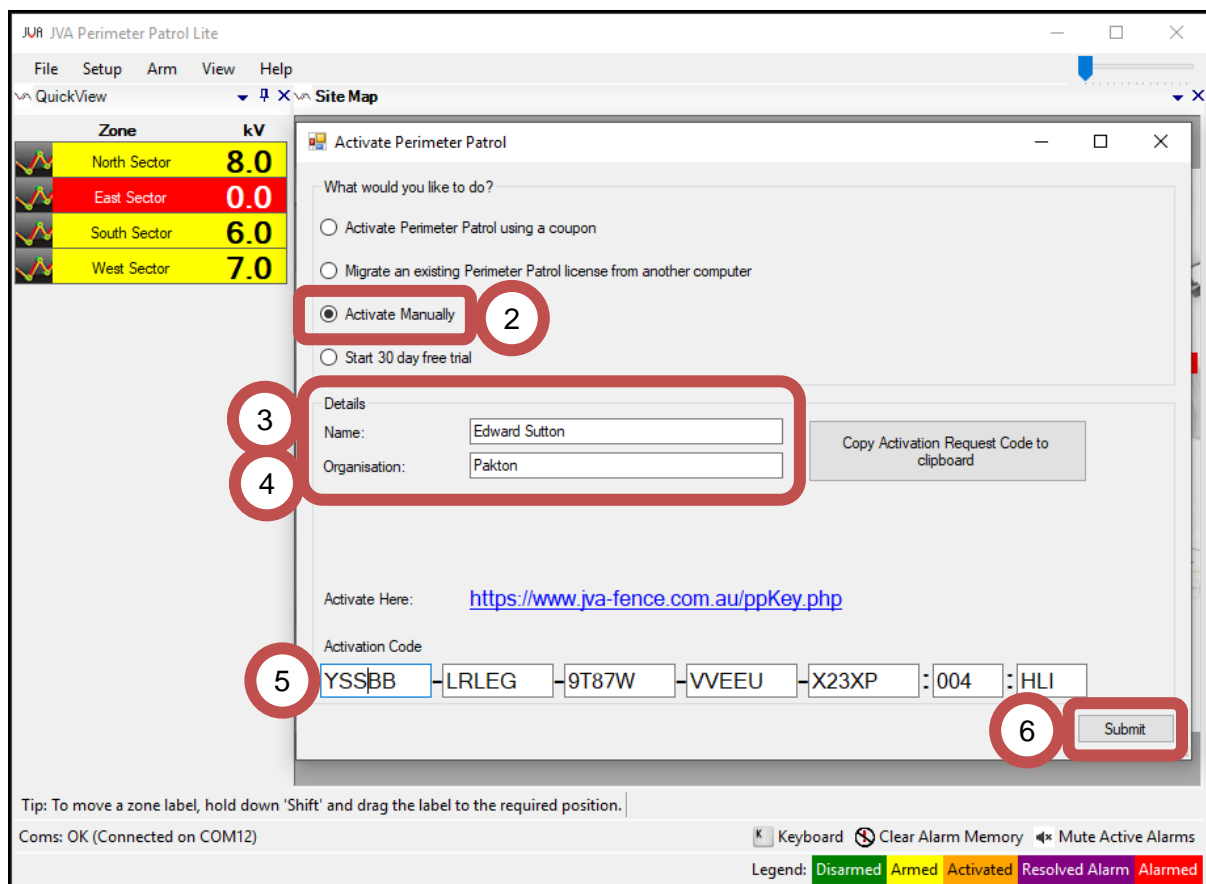

Figure 19 – Activating Manually

Alternatively, if you do not know your Activation Code and you are activating using a coupon, you can click the **Copy Activation Request Code to clipboard** and click the **Activate Here** link.

The Website for requesting an activation code should appear in your Internet Browser.

1. Click into the Activation Request Code box and press Ctrl-V to paste the code
2. Enter the Coupon into this box. Your vendor should have provided you with one
3. Enter the email address you want the activation code to be delivered to
4. Press the Submit button

The Email Success page should now be shown. You can close the Internet Browser down now

**Perimeter Patrol  
Activation Code Form**

*fill out the form below to get an Activation Code for Perimeter Patrol sent to your email address. You can enter either a coupon or an existing Perimeter Patrol Activation Code or both if you would like to upgrade. This form can be used to upgrade your previous licence to include HLI and more zones. You will be invoiced for each additional zone and for enabling the HLI feature.*

-Enter Activation Code:

-Enter Coupon:

Enter your Activation Request Code here:  
 7BAF405D2667461C7DD3BA2479D4688B28603620EF433193F9  
 C07B9D6EDB24773974910CD6CD478F1503BFB01E0315892B  
 27BC47BDE45263DB459BE5114D9861EC1DC803B88D580B39  
 5A29BFFDF85ABFA0DBD705D6C21B504DF52D886E97AB67

-Enter the email address that you would like us to send the Activation Code to:

**WARNING:** The fields below should be left blank unless you want to upgrade your current licence to have more zones or enable the Perimeter Patrol HLI feature. You will be charged for these extra features!

-HLI:

Please enter the number of zones you would like to have (minimum of 4 - maximum of 999) - this is only relevant to coupon purchases, not those refreshing an old Activation Code:

Submit

*Note: The form image includes red callout boxes numbered 1 through 4. Callout 1 points to the Activation Request Code field, callout 2 to the Coupon field, callout 3 to the email address field, and callout 4 to the Submit button.*

You will receive an email with your new licence key.

1. Copy the licence key from the email
2. Click the first box directly under **Activation Code**
3. Press Ctrl-V to paste the licence key
4. Click the **Submit** button

### 4.4 Activating with the 30 day demo licence

The Demo Licence will enable the entire functionality of Perimeter Patrol for 30 days (excluding Cloud Backup) to allow the User to trial the software. To do this do the following:

1. Click **Setup** → **Licensing**
2. Select **Start 30 day free trial**
3. Click Submit

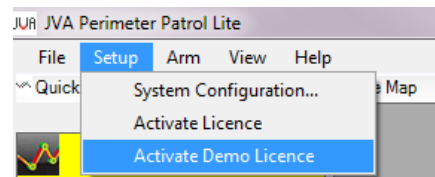

A warning box will appear. Click the Yes button to continue.

The Demo Popup configuration window will appear. This allows you to create a friendly reminder to the User to purchase Perimeter Patrol.

1. Enter your reminder note
2. Optionally: If the site has internet access, press the Add Button to add a HyperLink Button to the Popup that links to your website

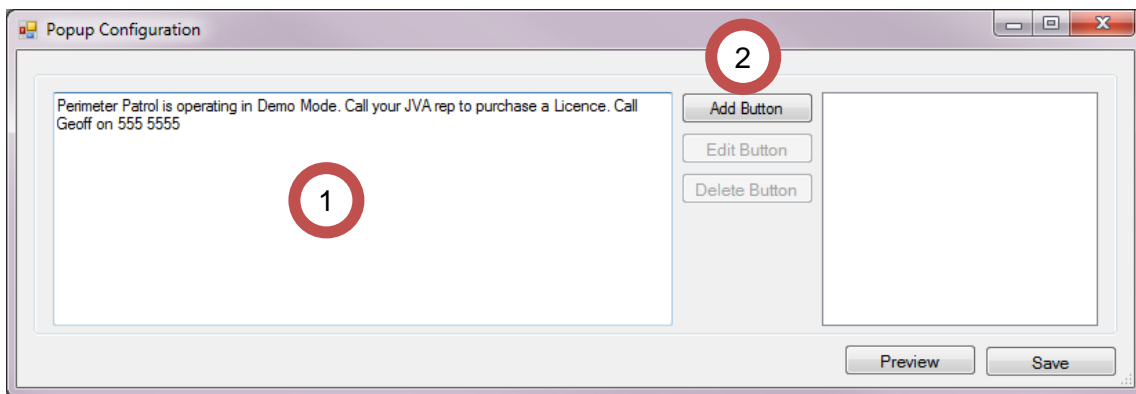

Figure 20 – Demo Popup Configuration

3. Update the Button Text
4. Update the HyperLink / URL you want the Internet Browser to go to when the button is pressed
5. Press Save

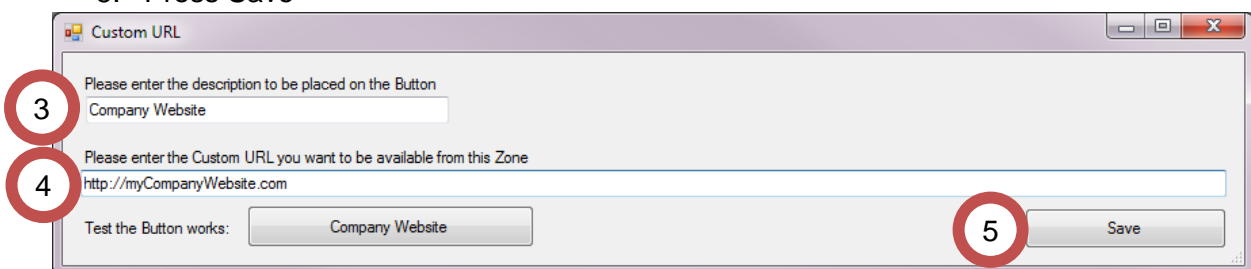

Figure 21 – Demo Popup Button

6. The Hyperlink text can be copied directly from an Internet Browser to ensure the button is directed to the correct page



Add as many buttons as you want to the Popup.

Press the Preview Button to see the Popup in its final form.

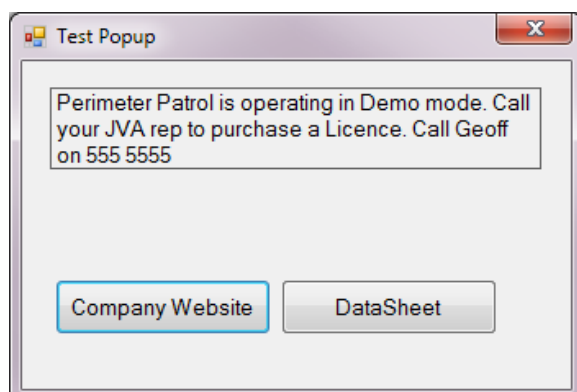

Figure 22 – Example Demo Popup

Perimeter Patrol will now close.

## 4.5 Logging into Perimeter Patrol Pro

After you have started JVA Perimeter Patrol, it will prompt you to enter your login username and password. JVA Perimeter Patrol comes packaged with the following default credentials:

- Username: **Admin**
- Password: **0000**

Enter these details in the login prompt and click **OK**. You may be wondering at this point what the **Connection Settings** button is for, but we'll introduce it later in this installation and configuration manual.

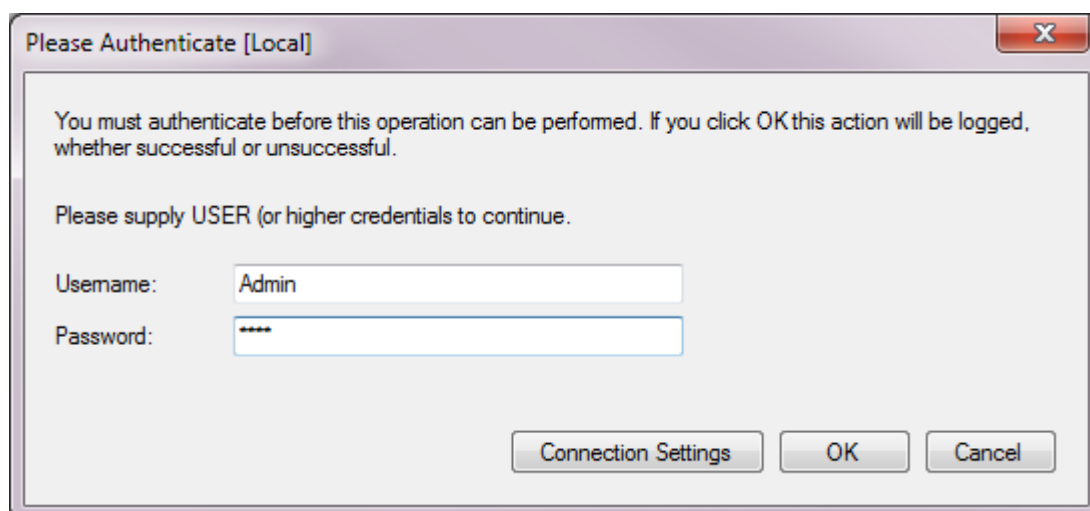

Figure 23 - Logging in for the first time

## 4.6 Changing the Administrator password

Change the Administrator password to a value that is known only to you and other system administrators.

1. Click **Setup** → **System Configuration**
2. Select the **Users** tab
3. Click the **Change Administrator Password** button.

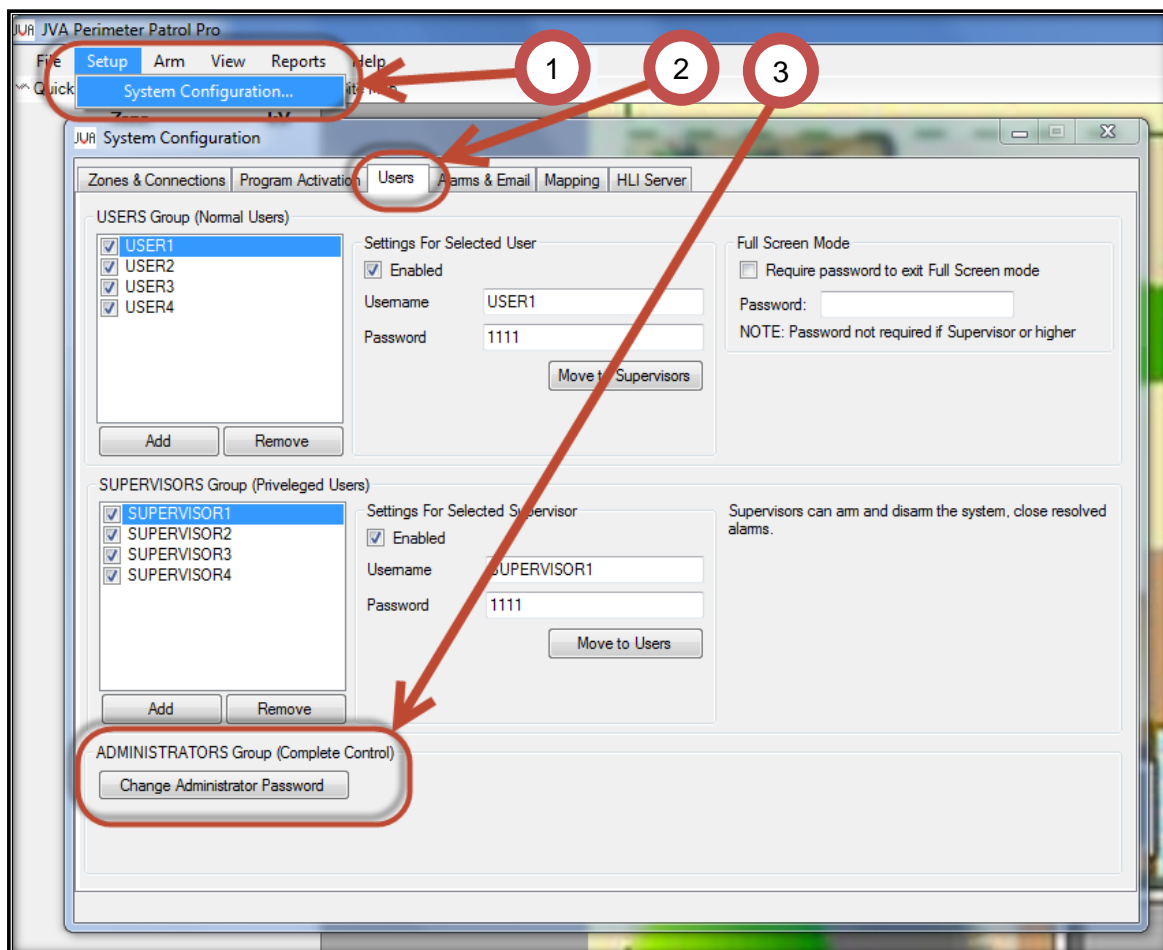

Figure 24 - Changing the Administrator password

## 4.7 Configuring user accounts

While the **Users** configuration tab is open, you may like to take the opportunity to setup the user accounts. JVA Perimeter Patrol comes preconfigured with four default User-level accounts and four default Supervisor-level accounts.

- Click to select any user and modify its username and password.
- Click the **Add** buttons to create a new user.
- Click the **Remove** buttons to remove any selected user.
- Modify a selected user's username and password.

### 4.7.1 Enabling and disabling user accounts

Sometimes you may need to prevent a certain user account from being able to log in. An example of this may be when somebody from your company goes away on holidays.

- Select their user name
- Click the **Enabled** check box to enable and disable their account.

### 4.7.2 Promoting and demoting users

A user account in the Users Group has the lowest level of access permissions. To give that user account a higher level of access permissions, you can promote it to the Supervisor Group by clicking the **Move to Supervisors** button. Similarly, you can demote any user account from the Supervisor Group down to the User Group by clicking the **Move to Users** button.

### 4.7.3 Summary of user access permissions

	Users	Supervisors	Administrators
View zone voltages and alarms	✓	✓	✓
Control energisers		✓	✓
Close resolved alarms		✓	✓
Exit full screen mode		✓	✓
System Configuration			✓

Most of the time, JVA Perimeter Patrol operators only require User access permissions level. It is expected that you will setup JVA Perimeter Patrol so that the operators have to request a manager with supervisor-level access permissions to perform higher level functions for them.

#### 4.7.4 Configuring full screen mode

Full screen mode is the remaining setting for you to configure in the Users panel. It is expected that you will configure JVA Perimeter Patrol to run in full screen mode and block operators from accessing other programs on the computer. To achieve this, you will have to set a password to prevent operators from exiting full screen mode.

This password is only required when the operator has logged into JVA Perimeter Patrol with an account that has user-level access permissions. The password cannot prevent supervisors from exiting full-screen mode.

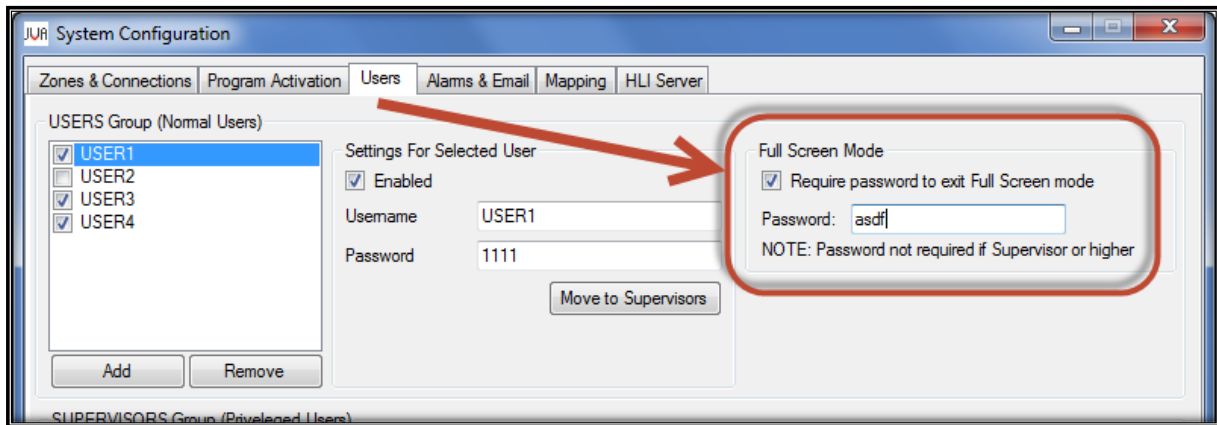

Figure 25 - Setting a password to prevent operators from exiting full screen mode



### 4.8 Configuring alarms and email

JVA Perimeter Patrol can send emails based on a large number of Email Topics if the computer is connected to the internet.

1 Click **Setup** → **System Configuration** and select the **Alarms & Email** tab

To Enable the Email system, the **Manage Emails** button needs to be clicked. This will open the Email Contact Window

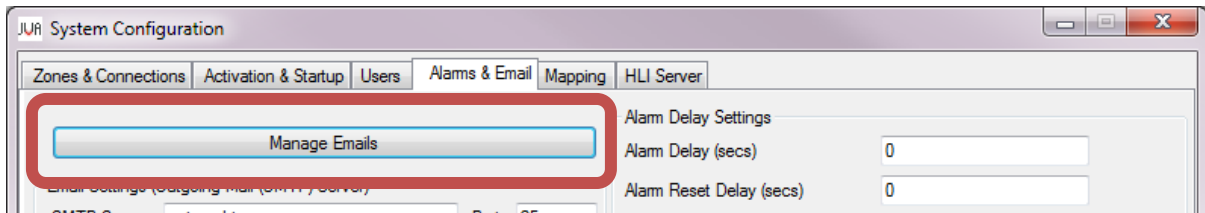

Figure 26 – Enable Emails

1. Press the **Add New** button to add a new Email Contact
2. Change the **To Address** to the correct Email Address
3. Optional: Tick the **Use Custom Email Subject** box to use the same Subject for all Emails to this Recipient. Enter the new Subject into the text box. This can be very useful when using an Email2SMS service
4. Tick the Email Topics to be sent to the Contact
5. Continue to Add More Email Addresses to the Contact list using steps 1-4
6. Once all of the Email Contacts have been added, press the Close Button

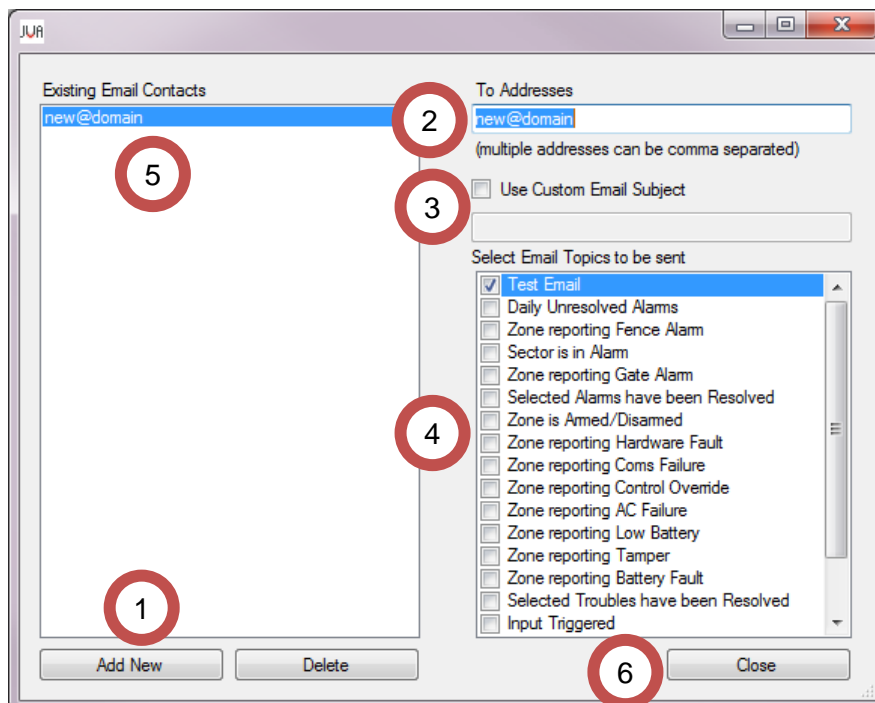
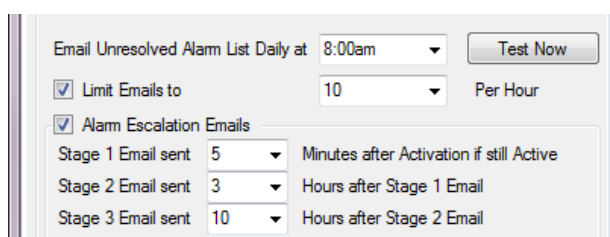

Figure 27 – Add Email Contacts

1. You must provide a reliable outgoing email server (**SMTP**) and **From Address**
2. The **Site Name** will be added to the Email Subject (unless a Custom Subject is require) allowing quick identification/sorting of Emails for the User
3. If the Server Requires Authentication, tick the box and enter the required Username and Password
4. If the Email Server Authentication requires SSL Encryption, tick the box
5. Click on the **Test SMTP Settings** button confirm that email settings are working correctly. An Email will be sent to all Contacts that have the **Test Email** topic ticked



Figure 28 – Configure Emails settings



Configure the final section of the Email system

The **Email Unresolved Alarms** time needs to be altered if the **Daily Unresolved Alarms** topic is to be sent to a Contact

Tick the **Limit Emails to** checkbox if you are expecting a lot of emails due to this site. The Number of Emails Per Hour can then be chosen. This is not a Total Number of Emails sent per hour, each contact will receive up-to this limit of emails per hour.

The Alarm Escalation system provides a way to alert Site Supervisors / Installers / Managers of un-resolved issues on a site without troubling them with more mundane issues. The various Emails will be sent to the Contacts who have the Topic checked.

For the above example: The Stage 1 Email will be sent **5 minutes** after an Alarm Activation if it is still active. If the Alarm has been Resolved, the Email will not be sent.

If still un-resolved after another **3 hours**, the Stage 2 Email will be sent, followed by the State 3 Email **10 hours** later. This means that the Stage 3 Email will be sent 13 hours and 5 minutes after the initial Alarm Activation.

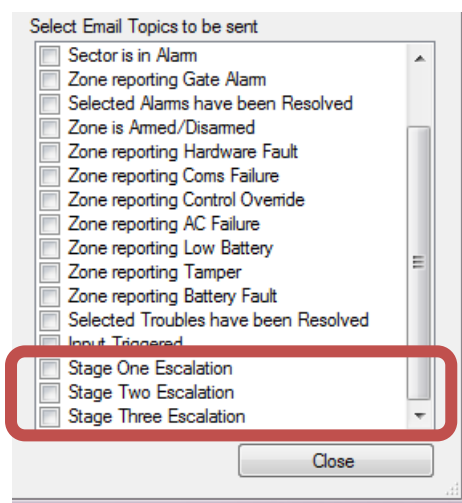

### 4.8.1 Alarm Delay Settings

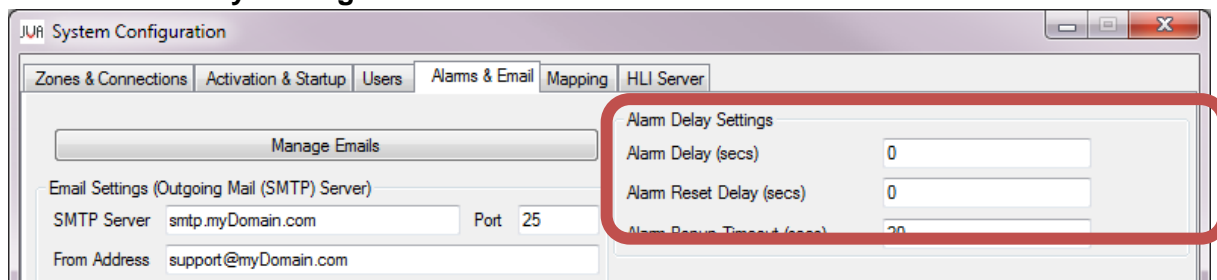

Figure 29 – Configure Alarm Delay settings

Section 2 of the configuration settings shown below contains settings that you can configure to prevent JVA Perimeter Patrol from reacting too quickly to changing alarm conditions.

The **Alarm Delay** setting allows you to specify the number of seconds an alarm condition must be present before JVA Perimeter Patrol logs it and raises an alarm.

The **Alarm Reset Delay** setting allows you to specify the number of seconds an alarm condition must be gone before JVA Perimeter Patrol will mark the alarm as being resolved.

Keep these values as small as possible to make JVA Perimeter Patrol react quickly to alarm circumstances. Increase them if you find that intermittent alarm conditions are causing JVA Perimeter Patrol to cycle too rapidly in and out of alarm state.

### 4.8.2 Alarm Popup Timeout

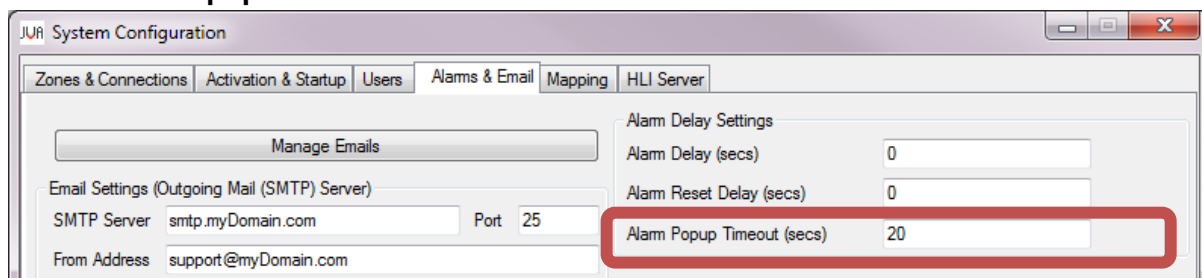

Figure 30 – Configure Alarm Popup

If an Alarm Popup has been configured for a Zone/Input/Sector, it will automatically close after the Timeout has elapsed. Refer to section 7.3 Alarm Popups for configuration information.

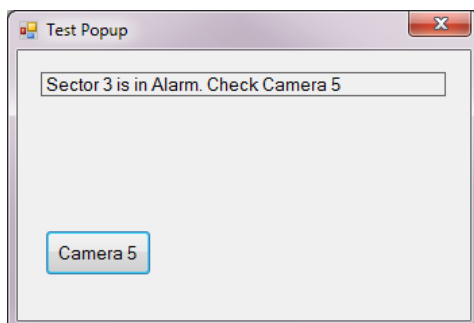

Figure 31 – An example of the Alarm Popup for Sector 3

## 5 Configure Cloud Backup

### 5.1 Enable Cloud Backup for the first time

Version 6 of perimeter patrol allows users to backup their Perimeter Patrol configuration including their site map to the cloud. Note: this currently excludes backing up the logs.

This is useful if your computer hard drive crashes and you need to rebuild everything. To enable this feature:

- 1 Click Setup → Cloud Backup
- 2 Check Enable Cloud Backup
- 3 Check **Start Fresh – disregard any previous backups**
- 4 Click Ok

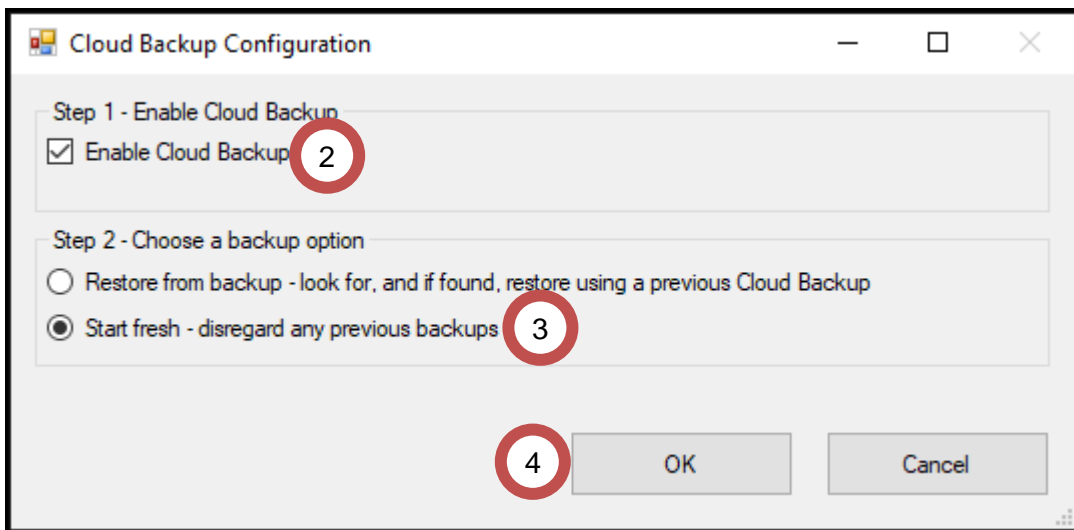
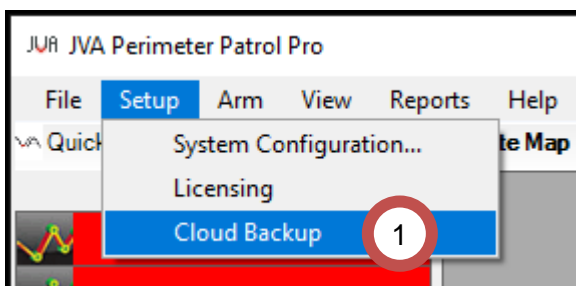

Once you have closed the form, you can see in the taskbar that your config is backing up.

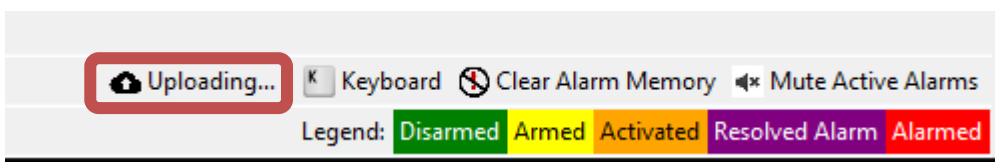

Once complete, it will revert to **Cloud Backup Enabled**.

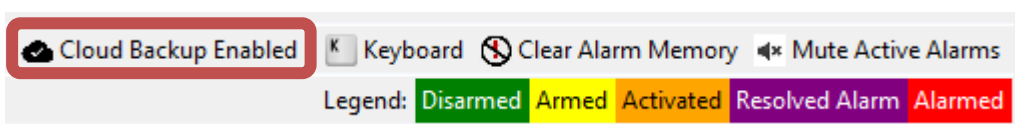

## 5.2 Disabling Cloud Backup or Restoring from a previous backup

Should you wish to disable the cloud backup feature do the following:

- 1 Click Setup → Cloud Backup
- 2 Click **Disable Cloud Backup feature**

Should you wish to restore from a previous backup do the following:

- 1 Click Setup → Cloud Backup
- 2 Click **Restore from a previous backup**

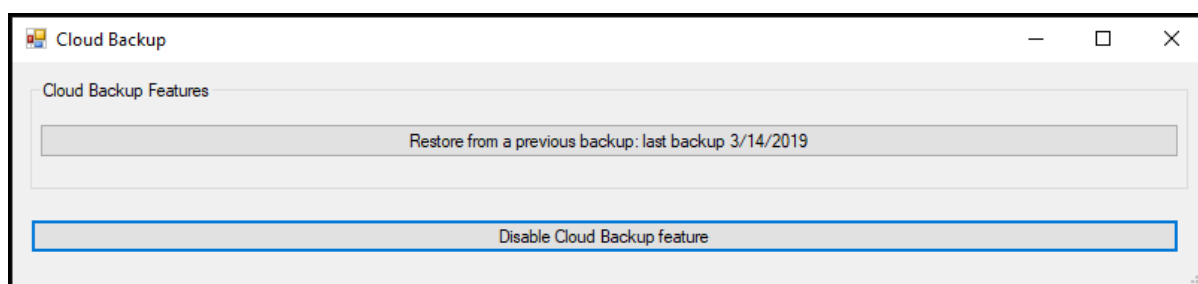

## 5.3 Migrating to a new PC and recovering from a backup

Perhaps you have had a hard drive failure, or you are simply moving from one PC to another. After you have successfully migrated your license to the new computer, you can restore your old settings from the cloud backup. To do this:

- 1 Click Setup → Cloud Backup
- 2 Check Enable Cloud Backup
- 3 Check **Restore from backup – look for, and if found, restore using previous Cloud Backup**
- 4 Click Ok

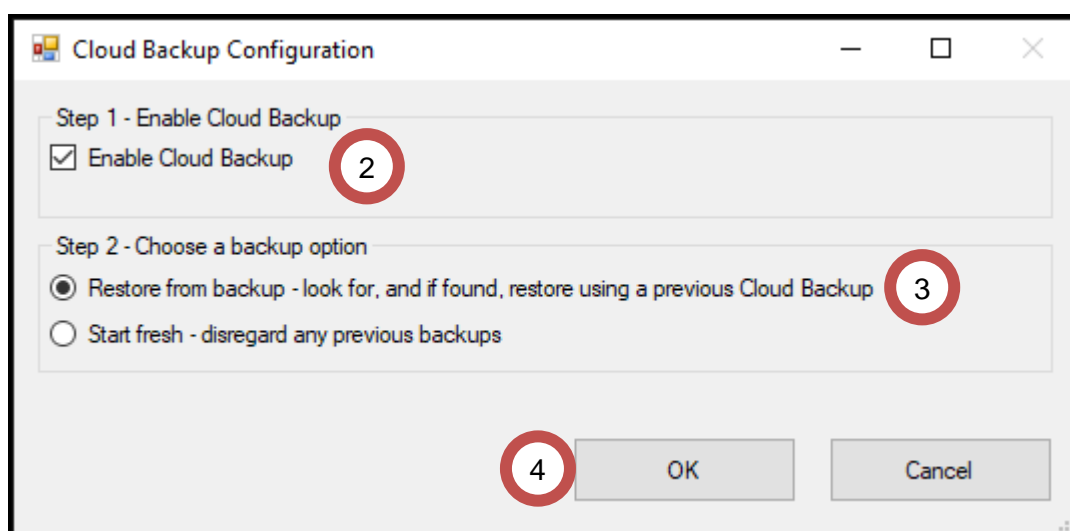

Wait for the backup to download.

## 6 Configuring the Site

### 6.1 Connect using Serial Communications (RS232 or USB)

#### 6.1.1 Scanning to detect zones

1. Click **Setup** → **System Configuration**
2. Click **Zones & Connections** tab
3. Select **USB**
4. Select a serial Com Port to open
  - a. You must have devices attached before com ports become available
5. Click on the **Open** button
6. Click the **Add / Remove Zones** button
7. Click the **Scan** button

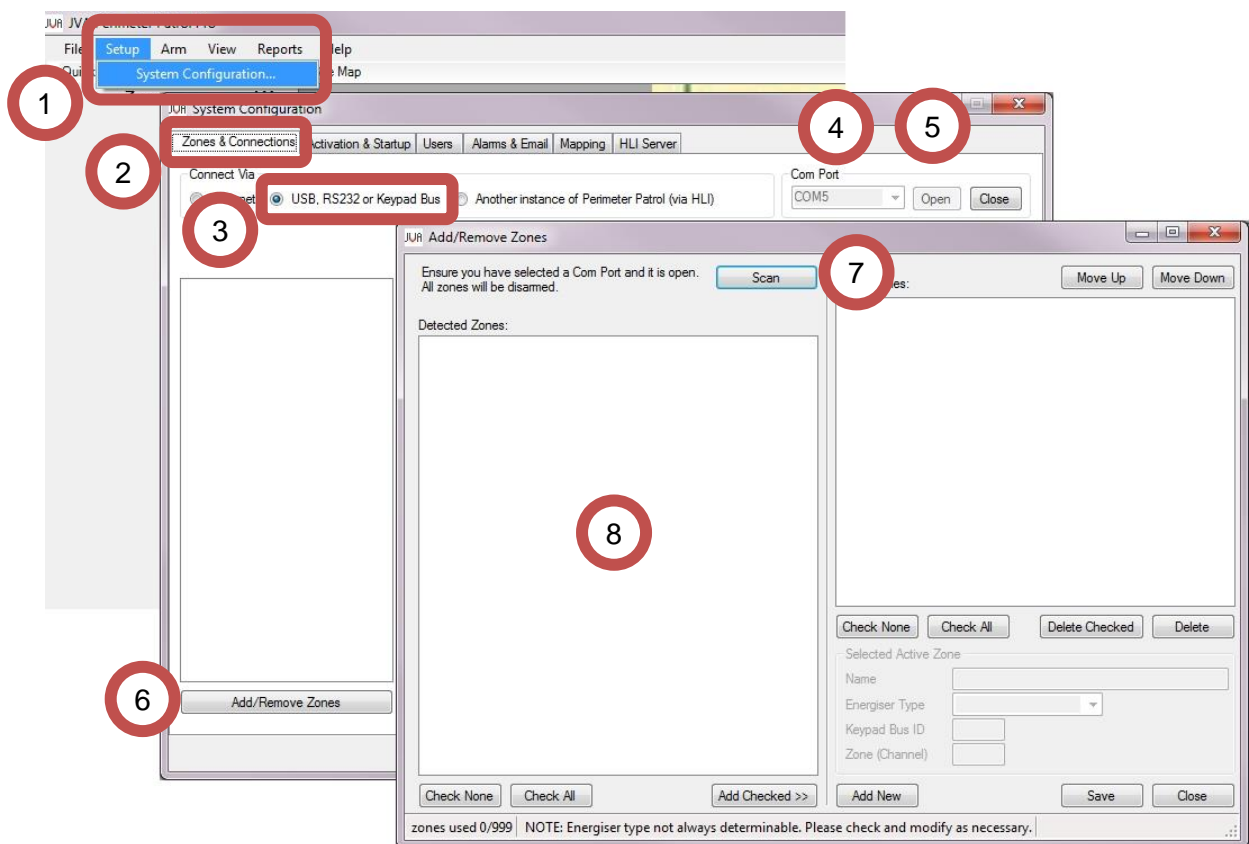

Figure 32 - Configuring zones using serial communications

8. After performing the scan, detected zones will begin to appear in the **Detected Zones** list. A **zone** is a section of fence that is powered by an energiser. The zone is individually monitored and can be armed or disarmed independently from other zones. Some energisers can power more than one zone.

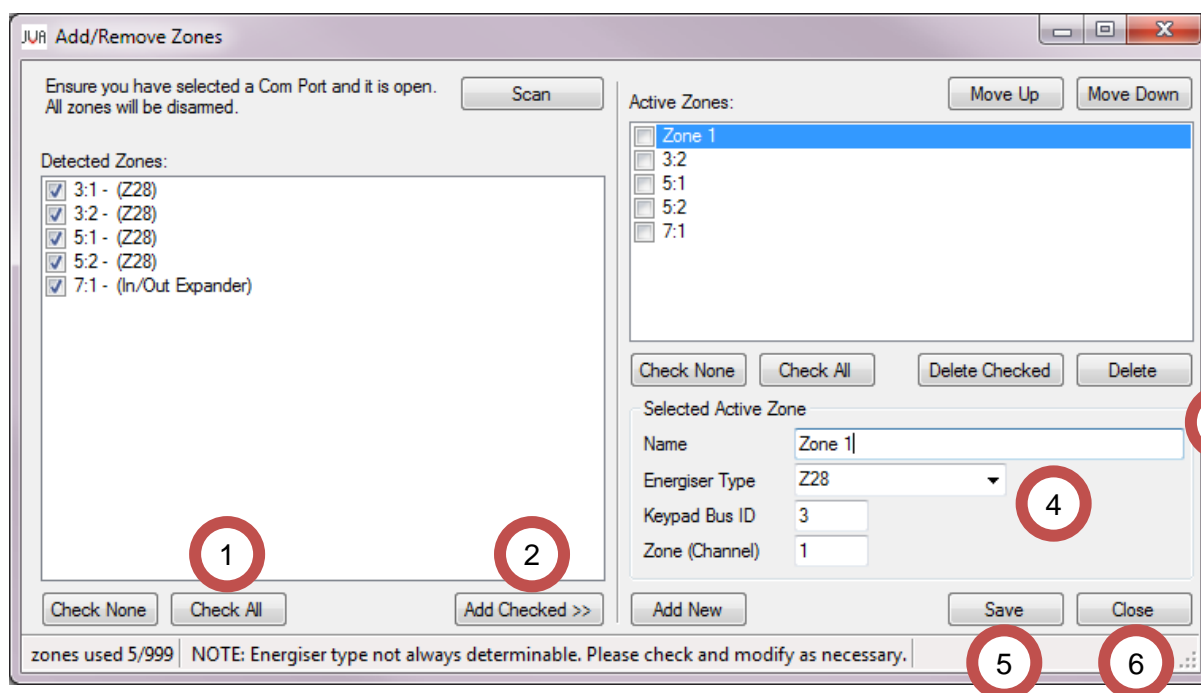

Figure 33 – Adding and Editing zones

### 6.1.2 Understanding detected zones

Each detected zone has a unique descriptor which helps you identify it. The unique descriptor has the form:

<Device Keypad Bus ID>:<Zone Index> - (<Device Type>)

The first detected zone in the illustration above has the descriptor: **3:1 – (Z28)**, which has the following meaning:

- The device powering or monitoring the zone has a Keypad Bus ID = 3.
- This zone is the first zone in the device.
- The zone belongs to a device of “Z28” type.

### 6.1.3 Adding and configuring zones

- Choose the zones you wish to monitor and control with JVA Perimeter Patrol.
- Add them to the **Active Zones** list on the right. You can add them individually or all at once using the **Check All** and **Add Checked** buttons (1 and 2)
- Give the zones user-friendly names (3)
- If the zone’s device type has not been correctly identified, you can modify it (4)
- Remember to **Save** (5) your zones before closing (6) the window

### 6.1.4 Other zone configuration utilities

You can re-order zones in the **Active Zones** list using the **Move Up** and **Move Down** button in the top-right of the zone configuration window.

You can manually add zones without scanning by using the **Add New** button at the bottom of the **Active Zones** list.

## 6.2 Connecting to an Ethernet Adapter (Local Area Network)

### 6.2.1 Connecting

1. Click **Setup** → **System Configuration**
2. Click **Connect via: Ethernet**
3. Click **Add / Remove Zones**

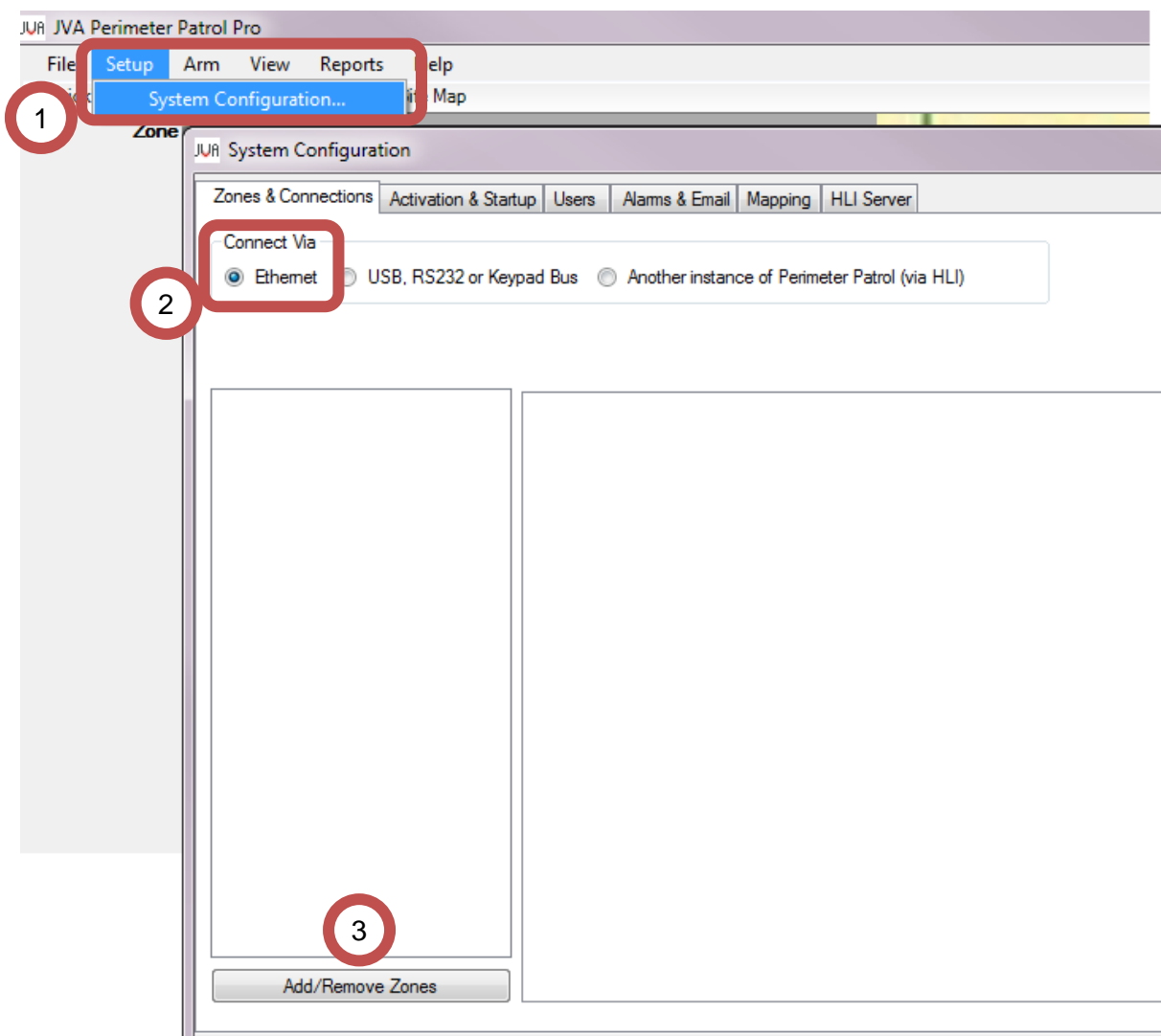

Figure 34 - Enter Add / Remove Zones



### 6.2.2 WinPcap Error Message

To communicate with JVA devices by TCP/IP protocol, JVA Perimeter Patrol requires that your computer have software called WinPcap installed. If WinPcap is not already installed, you will see a red error message at the bottom of the Add/Remove Zones window, as shown in the image below:

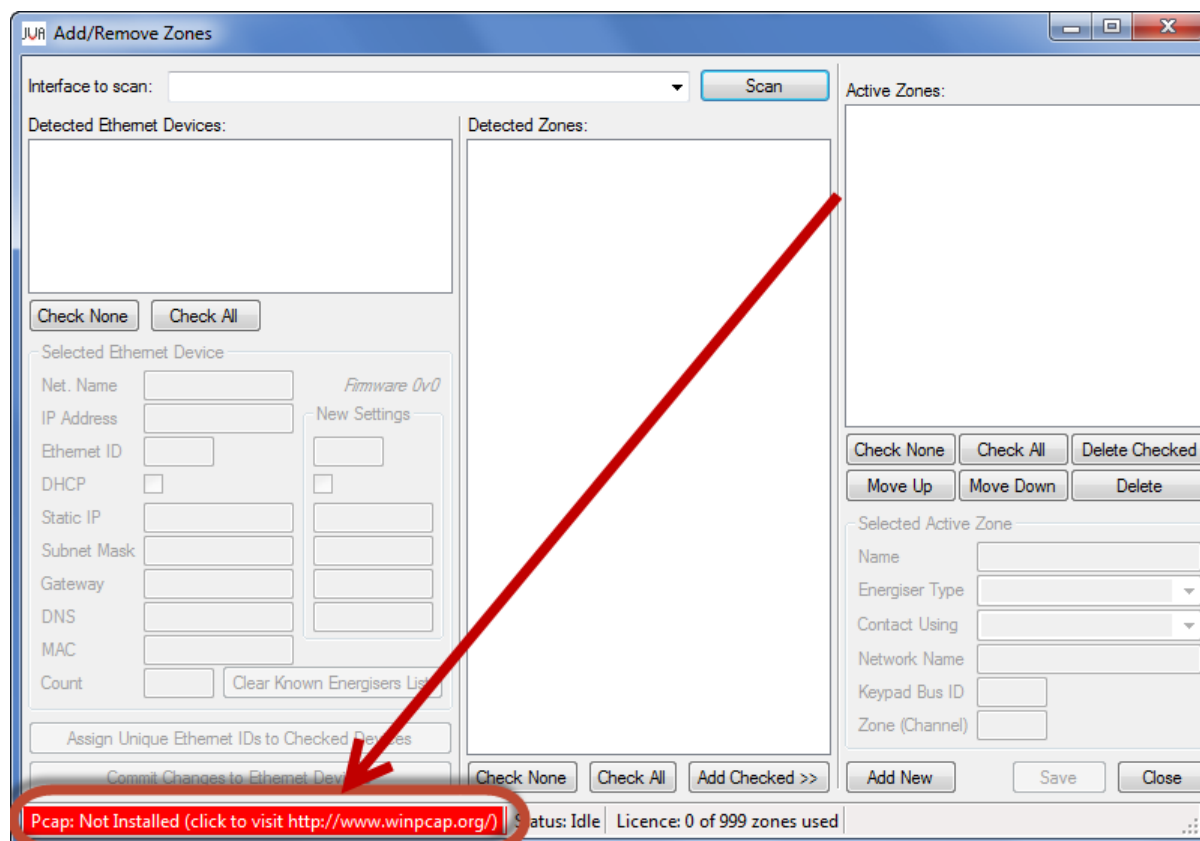

Figure 35 - WinPcap is not installed

To rectify this situation, exit Perimeter Patrol and then find the WinPcap installation file included in the JVA Perimeter Patrol setup bundle. Run this file to install WinPcap. See section 3.3.1

### 6.2.3 Scanning for devices and zones

1. Select the network device that you want to use
2. Click the **Scan** button

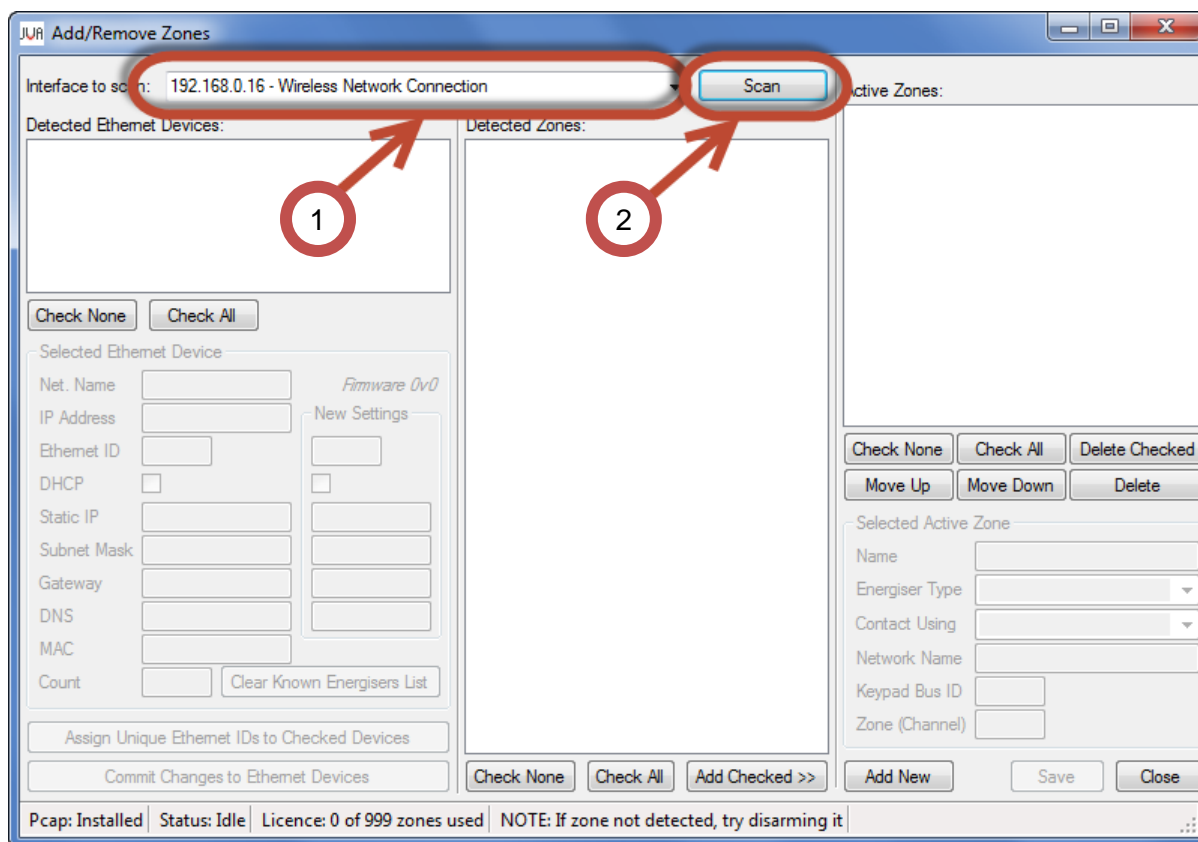

Figure 36 - Scan for zones

A list of detected Ethernet Devices will appear in the left column. A list of detected zones will appear in the middle column. The image below shows an example. This document will focus on the detected Ethernet Devices and their configuration first, and work with the detected zones in a later section of this document.

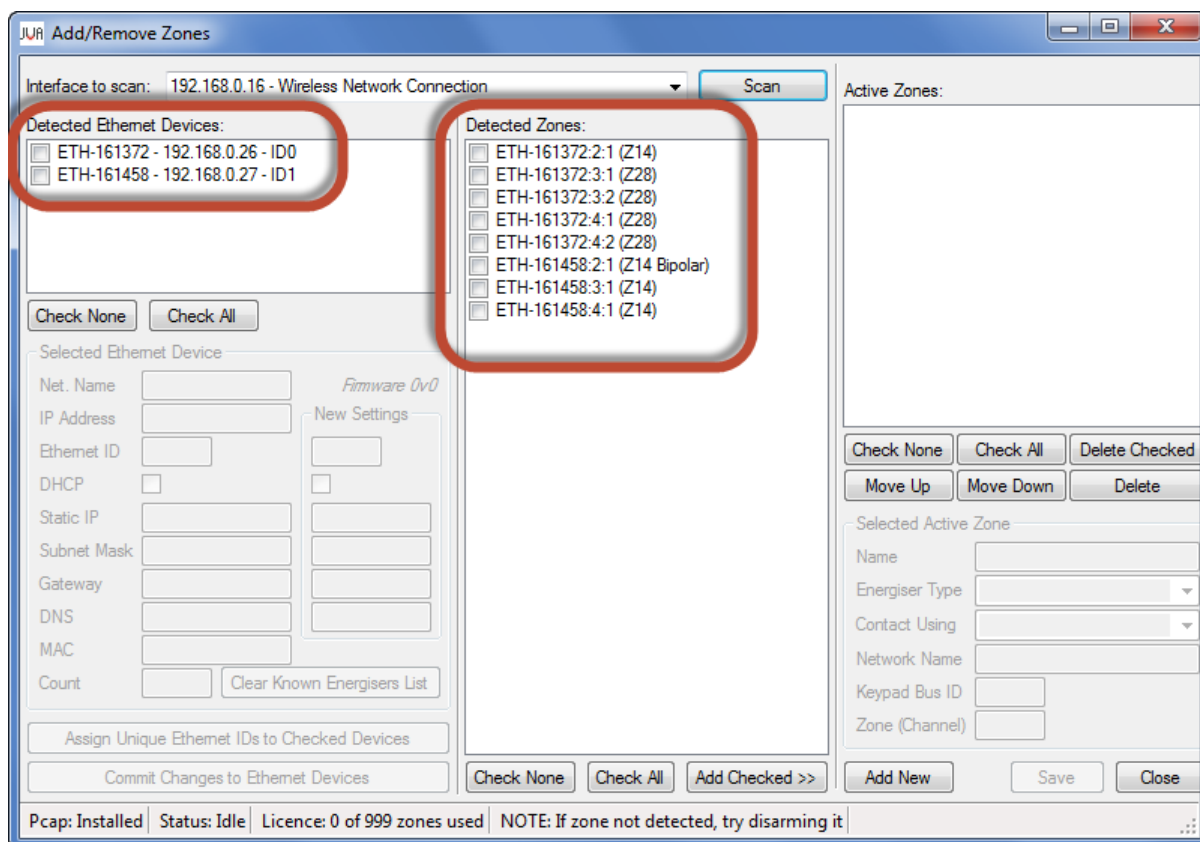

Figure 37 - Detected Ethernet devices in the left-most column. Detected zones are in the middle column.

### 6.2.4 Ethernet Adapter Descriptor

In the example image above, two Ethernet Adapters have been detected. The first in the list has the following three-part descriptor: **ETH-161372 - 192.168.0.26 - ID0**

Examples of each part of a descriptor are given in the table below.

Table 3 - Properties contained in the descriptor of a PAE212 Ethernet Adapter Device

Property Name	Example 1	Example 2
Network Name	ETH-161372	ETH-161458
IP Address	192.168.0.26	192.168.0.28
Ethernet ID	ID0	ID1

Each part of the three-part descriptor should be unique. No Ethernet Adapter should share the same Network Name, IP Address or Ethernet ID as another.

The last 6 digits of the Network name are the same as the serial number of the device, which you can find as a sticker on the device’s printed circuit board.

## 6.2.5 Configuring an Ethernet Adapter

Click the first Ethernet Device in the list of discovered Ethernet Devices. Its configuration settings will appear underneath.

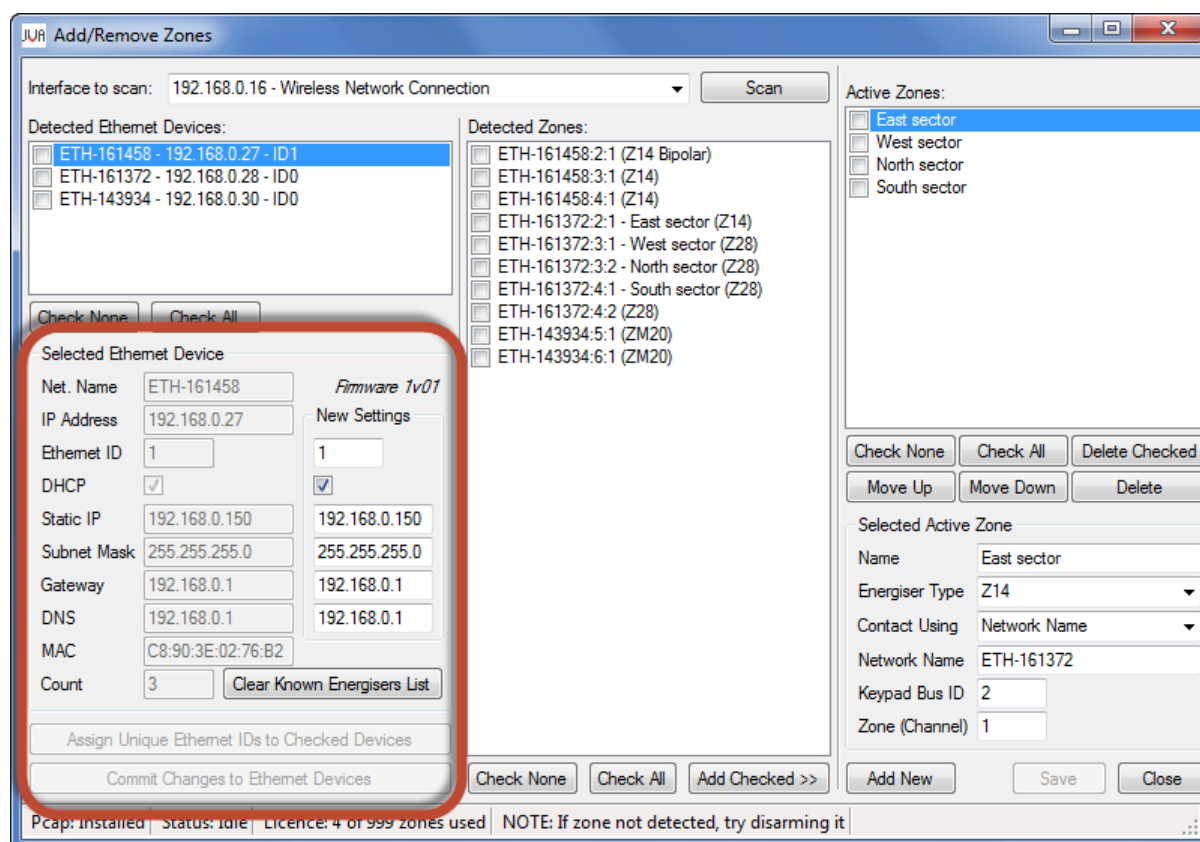

Figure 38 - Configuration Settings for a PAE212 Ethernet Adapter Device

### 6.2.5.1 Ethernet ID setting

Ethernet IDs are used by the Ethernet Adapters for communication between each other, particularly for the purpose of synchronizing energisers on the entire network.

Every Ethernet Adapter must have a unique **Ethernet ID** setting.

- Click the **Check All** button to select all the Ethernet Adapters
- Click the **Assign Unique Ethernet Ids to Checked Devices** button
- Click the **Commit Changes to Ethernet Devices** button

#### 6.2.5.1.1 Network settings

JVA Perimeter Patrol can contact the Ethernet Adapters by two methods, ordered from most recommended to least recommended.

- Static IP Address (DHCP disabled)
- Network Name (DHCP enabled)

Choose a system depending on the configuration of the LAN (Local Area Network), which you may not have control over. Most LANs will permit you to use static IP Address but some will not. Some LANs will permit you to contact the Ethernet Adapters using their **Network Name** (DHCP) but some will not.

**6.2.5.1.2 Network settings – Static IP Address (DHCP disabled) system**

If you decide to use the **Static IP Address (DHCP disabled)** system, follow these instructions.

- Choose a Subnet Mask that is NOT being used by other computers or devices on the network. Other computers on the network most commonly use a Subnet Mask of 255.255.255.0. Choose a different value to avoid IP Address conflicts.
- For each Ethernet Adapter in the Detected Ethernet Devices List:
  - Click the device to select it
  - Click the **DHCP** setting to **disable** it
  - Edit the **Static IP, Subnet Mask, Gateway and DNS**
- Click the **Commit Changes to Ethernet Devices** button

Make sure that you give each device a unique static IP address.

The **Gateway** and **DNS** settings are usually standard and don't need to be changed. Check with the Local Area Network (LAN) administrator if the LAN uses non-standard Gateway or DNS settings.

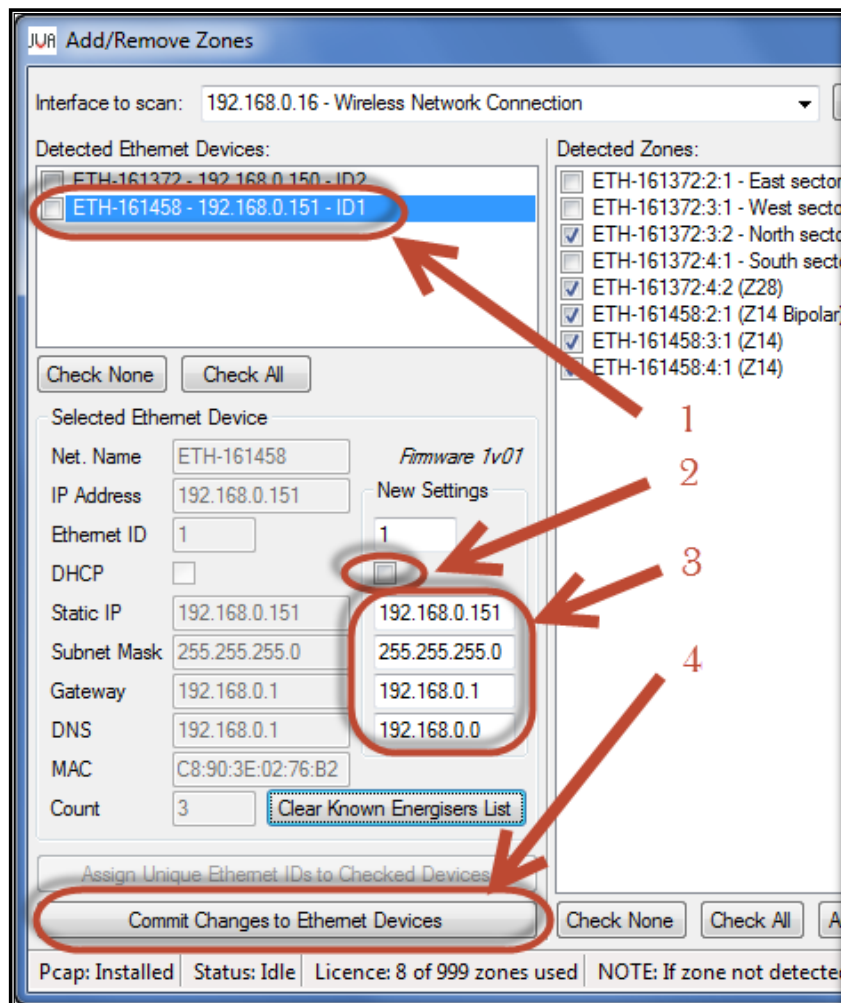

**Figure 39 - Configuring each PAE212 Ethernet Adapter Device to use Static IP Address. Note that DHCP is UNSELECTED.**

### 6.2.5.1.3 Network Settings – Network Name (DHCP enabled) system

If you decide to use the **Network Name (DHCP enabled)** system, follow these instructions:

- Choose a Subnet Mask that is NOT being used by other computers or devices on the network. Other computers on the network most commonly use a Subnet Mask of 255.255.255.0. Choose a different value to avoid IP Address conflicts.
- For each PAE212 Ethernet Adapter Device in the Detected Ethernet Devices list:
  - Click the device to select it
  - Click the **DHCP** setting to **enable** it
  - Edit the **Subnet Mask** to your chosen value
- Click the **Commit Changes to Ethernet Devices** button

### 6.2.5.1.4 Clear known energisers list

Ethernet Adapters remember the energisers and zone monitors that have been connected to them in the past, even if the energiser or zone monitor has been removed from the Keypad Bus. Use the **Clear Known Energisers List** button to command the Ethernet Adapter to “forget” about all the energisers it has seen in the past.

This is best performed while all devices are disarmed. The Ethernet Adapter will quickly determine the number and type of the devices connected.

Returning the Ethernet Adapter to its factory default settings (explained above in this document) will achieve the same result, but if you do that you will also have to re-configure its Network settings inside JVA Perimeter Patrol.

## 6.2.6 Adding electric fence zones to JVA Perimeter Patrol

When you have finished configuring the Ethernet Adapters, you will be ready to configure JVA Perimeter Patrol for monitoring and controlling each individual section of electric fence, called a zone.

All the zones that were detected will be displayed in the **Detected Zones** list, as illustrated in (Area 1) of the image below.

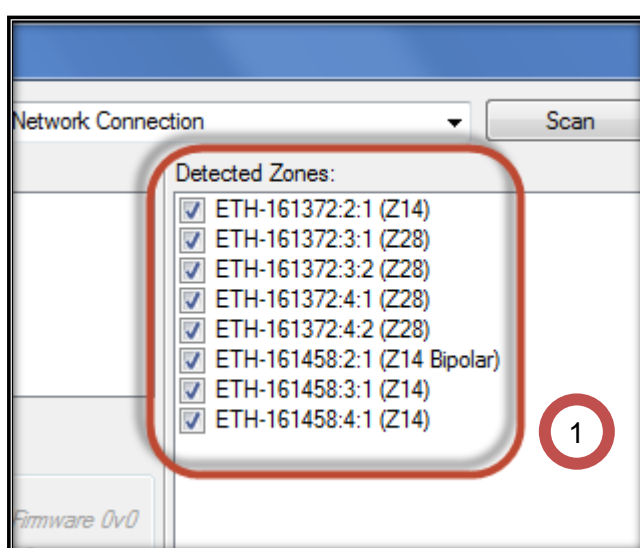

### 6.2.6.1 Using the electric fence zone descriptor to identify zones

Each zone can be uniquely identified from its descriptor as displayed in the Detected Zones list. To understand the descriptor, we will use our understanding of the network architecture described earlier in this document.

- **Zones** belong to **Security Electric Fence Devices** such as energisers and zone monitors. A zone is a section of electric fence that is individually armed, disarmed, and monitored. Alarms can be raised for each zone.
- **Security Electric Fence Devices** can have more than one **Zone** each.
- **Security Electric Fence Devices** are grouped on a **Keypad Bus** together with a **Ethernet Adapter**.
- There can be many **Ethernet Adapters**, each with its own group of **Security Electric Fence Devices**.

The first three fields of a zone's descriptor, separated by the ':' character, uniquely identify the zone by describing its position with respect to the network of devices. The final field of the descriptor, inside "()" brackets, is just a helper that tells you the type of device that powers or monitors the zone.

The descriptor of the first zone in the list in the image above is **ETH-161372:2:1 (Z14)**

	Example	Description
<b>Descriptor Part 1</b>	ETH-161372	Network Name of the Ethernet Adapter. The last six digits are the same as the serial number of the device.
<b>Descriptor Part 2</b>	2	Keypad Bus Id of the device powering or monitoring the zone.
<b>Descriptor Part 3</b>	1	Index of the zone with respect to the other zones powered or monitored by the same device. Also called the zone's <b>channel</b> .
<b>Descriptor Part 4</b>	(Z14)	The type of device that is powering or monitoring the zone.

### 6.2.6.2 Identifying devices from the zone descriptor

It may be helpful to note that the first two fields in the zone's descriptor also uniquely identify the device that is powering or monitoring the zone.

The first field in the descriptor, the network name of the Ethernet Adapter, can help you determine which Keypad Bus the device belongs to.

The second field in the descriptor, the Keypad Bus Id, uniquely identifies the device with respect to the Keypad Bus that it is connected to.

### 6.2.6.3 Choosing which zones to add to JVA Perimeter Patrol

Now that you understand how to identify zones from their descriptor, you can choose which zones you want to add to JVA Perimeter Patrol, and which zones you'd like to ignore.

For example, if an energiser can power two zones but you only use one zone, you would like to ignore the zone that is not being used.

### 6.2.6.4 Adding zones

Choose the zones you wish to view, monitor and control in JVA Perimeter Patrol as demonstrated in the image below (step 1). If you don't want to have all the available zones, you may add and remove them individually using the checkbox beside each zone. Once you have selected all of the zones that you wish to use with JVA Perimeter Patrol, press the "Add Checked >>" button (step 2).

Select any zone in the active zone list (step 3) and then give it a name (step 4) that is friendly and easy to understand. This is the name that JVA Perimeter Patrol will display to the users.

Be careful to make sure you set the **Contact Using** property correctly (step 5). The table below shows you which value you should use depending on the network system that you are using to connect to the Ethernet Adapters.

Network connection method	Contact zone using
Static IP Address (DHCP disabled)	IP Address
Network Name (DHCP enabled)	Network Name

Be sure to save your changes (step 6).

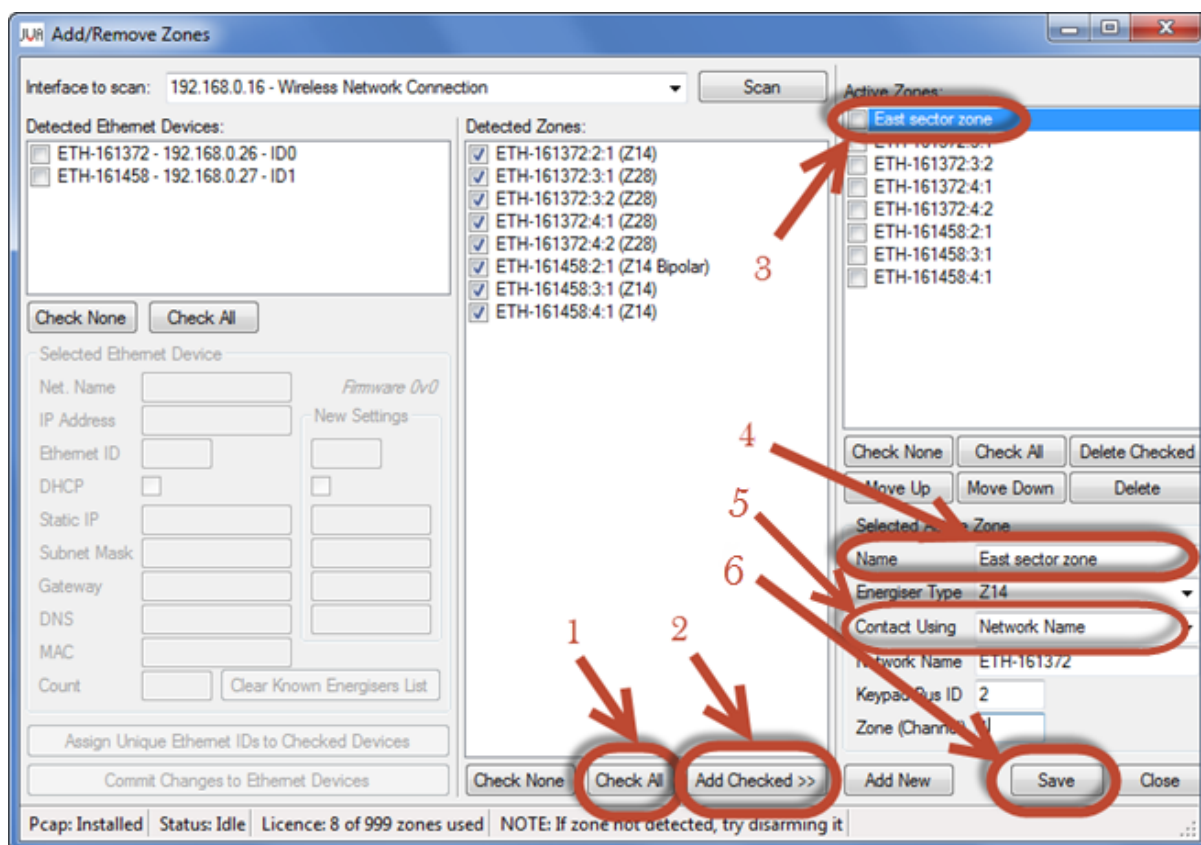
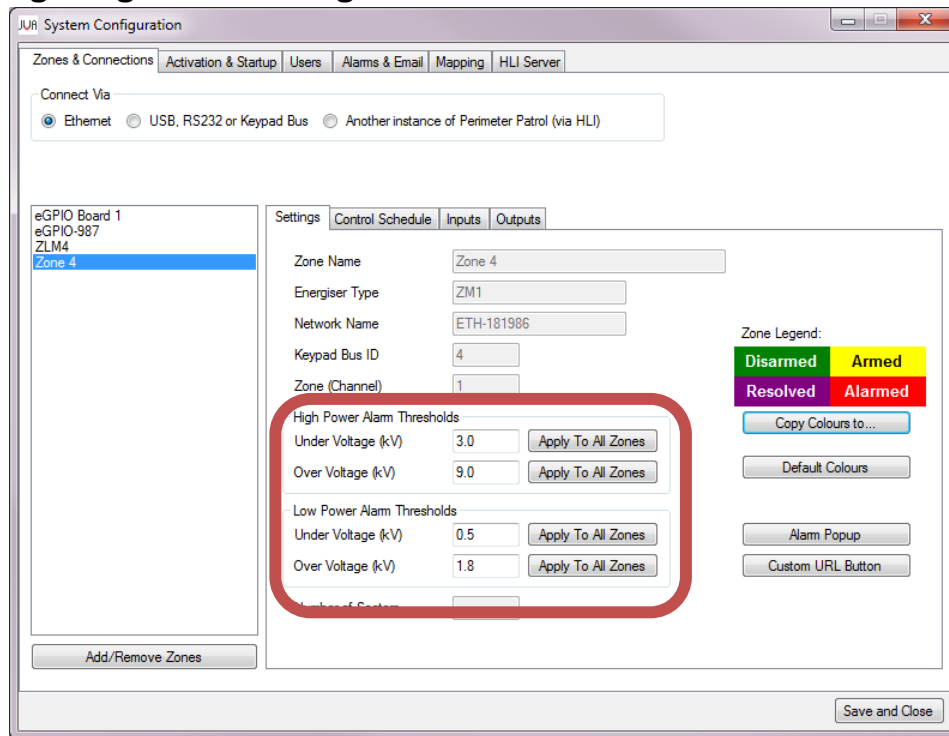

Figure 40 - Adding and naming zones



### 6.3 Configuring Zone Settings



Each Zone has configurable ‘Software Alarms’ that are only configured and triggered within Perimeter Patrol. These are found on the Settings Tab of each Zone.

These are additional alarms levels that use the voltage readings of the Energiser/Monitor to determine the Alarm Condition. If the voltage of the Energiser is more than the “Over Voltage” or less than the “Under Voltage”, the alarm will be triggered.

The alarms triggered are the UNDER VOLTAGE and OVER VOLTAGE alarms as displayed on the Zone Pop-up.

To Copy these thresholds to other Zones, click on the **Apply To All Zones** button.

#### 6.3.1 Setting Longitude and Latitude

New to version 6 of Perimeter Patrol is the ability to assign a location to Zone. When a Zone goes into alarm, the user can click on the zone in the **QuickView** and click **Show in Google Maps** to quickly see where the issue is. This additional Longitude and Latitude information is also provided in alarm emails.

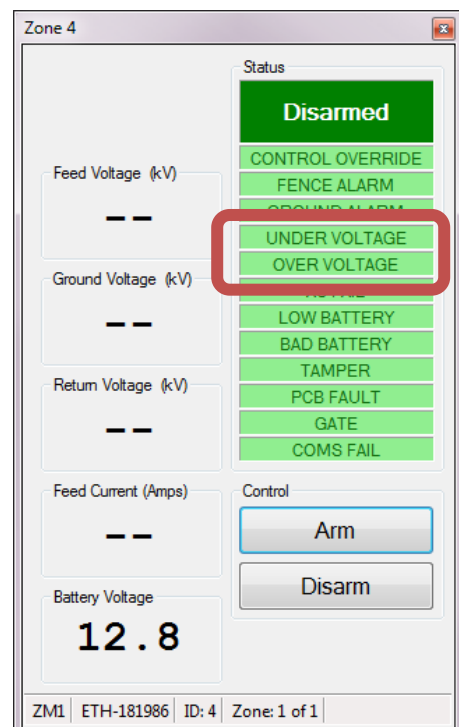

To set the longitude and latitude values simply fill in as shown:

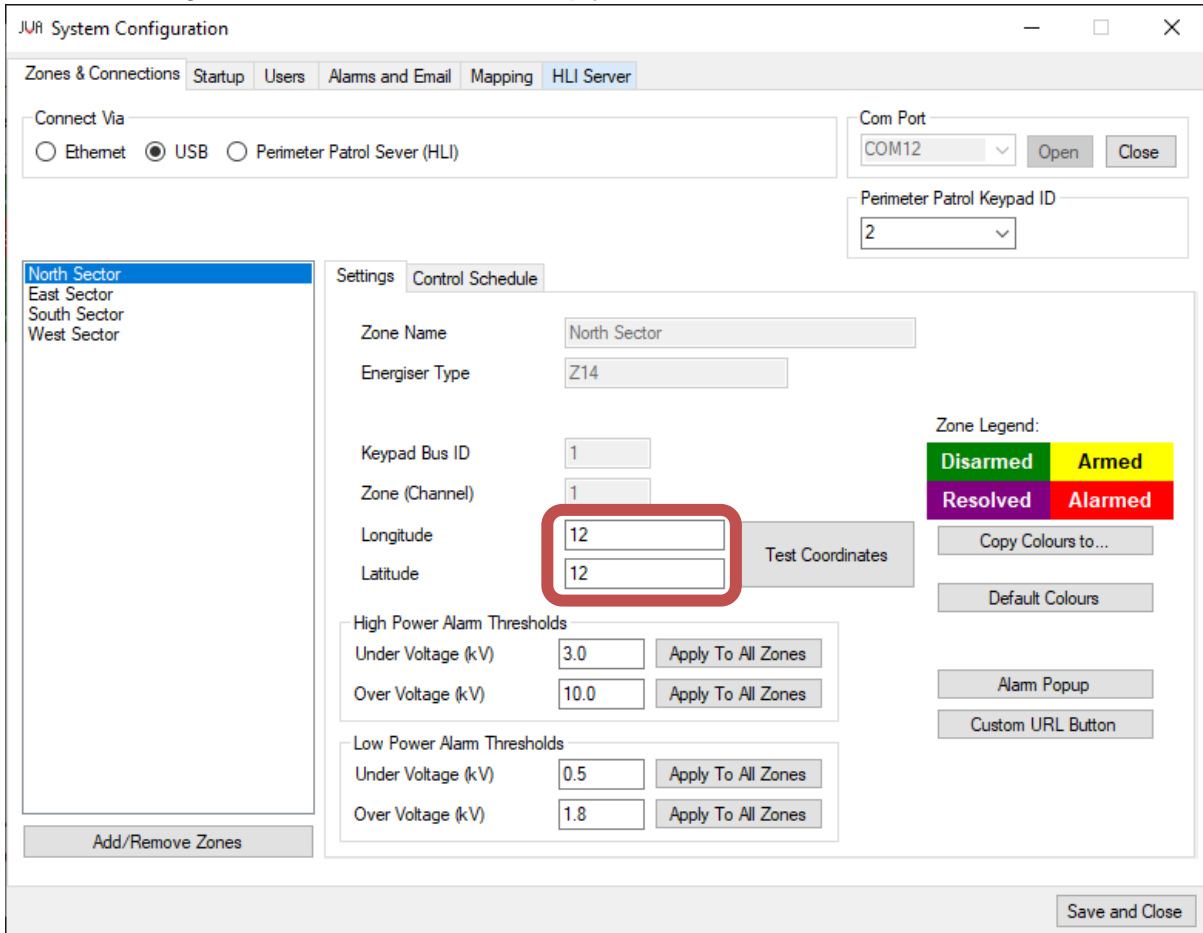

Figure 41 – Adding longitude and latitude to a Zone

Click **Test Coordinates** to check that it opens correctly in Google chrome.

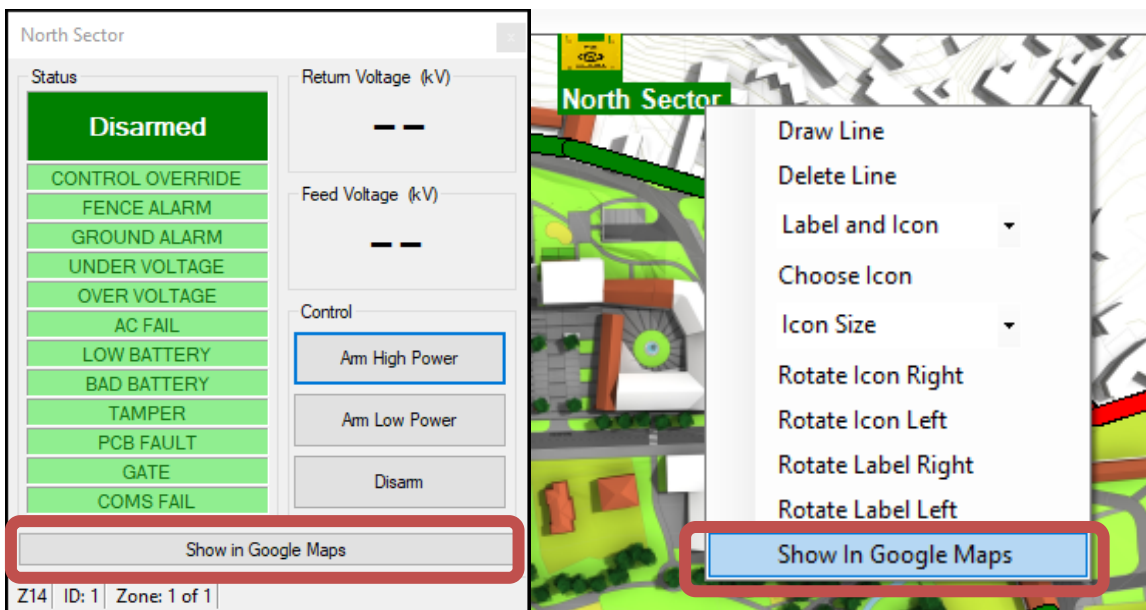

Figure 42 – Showing the google maps button in the QuickView and the right click context menu for a zone

### 6.4 Setting the control schedule for a zone

JVA Perimeter Patrol will allow you to setup an automatic control schedule for each zone.

1. Click **Setup → Configuration**
2. Click **Zones & Connections**
3. Select the zone you want to set the control schedule for
4. Click **Control Schedule**
5. Click on each time period to set it to any of the following values:
  - Arm High Power
  - Arm Low Power
  - Disarm
6. After setting a value in a single time slot, you can drag it to fill a range of timeslots with the same value. This can make it very fast and simple to set complicated schedules, removing the need for you to individually click each timeslot.
7. If you want this Schedule to be copied to another Zone, click the Copy Schedule to button and select the Zones in the opened Window
8. However, if you wish to apply the same schedule to all the other zones, click the **Apply Schedule to all Zones** button.

The zone in the example shown below is disarmed at all times except 1:30am to 6:30am on Monday when it is armed at high power.

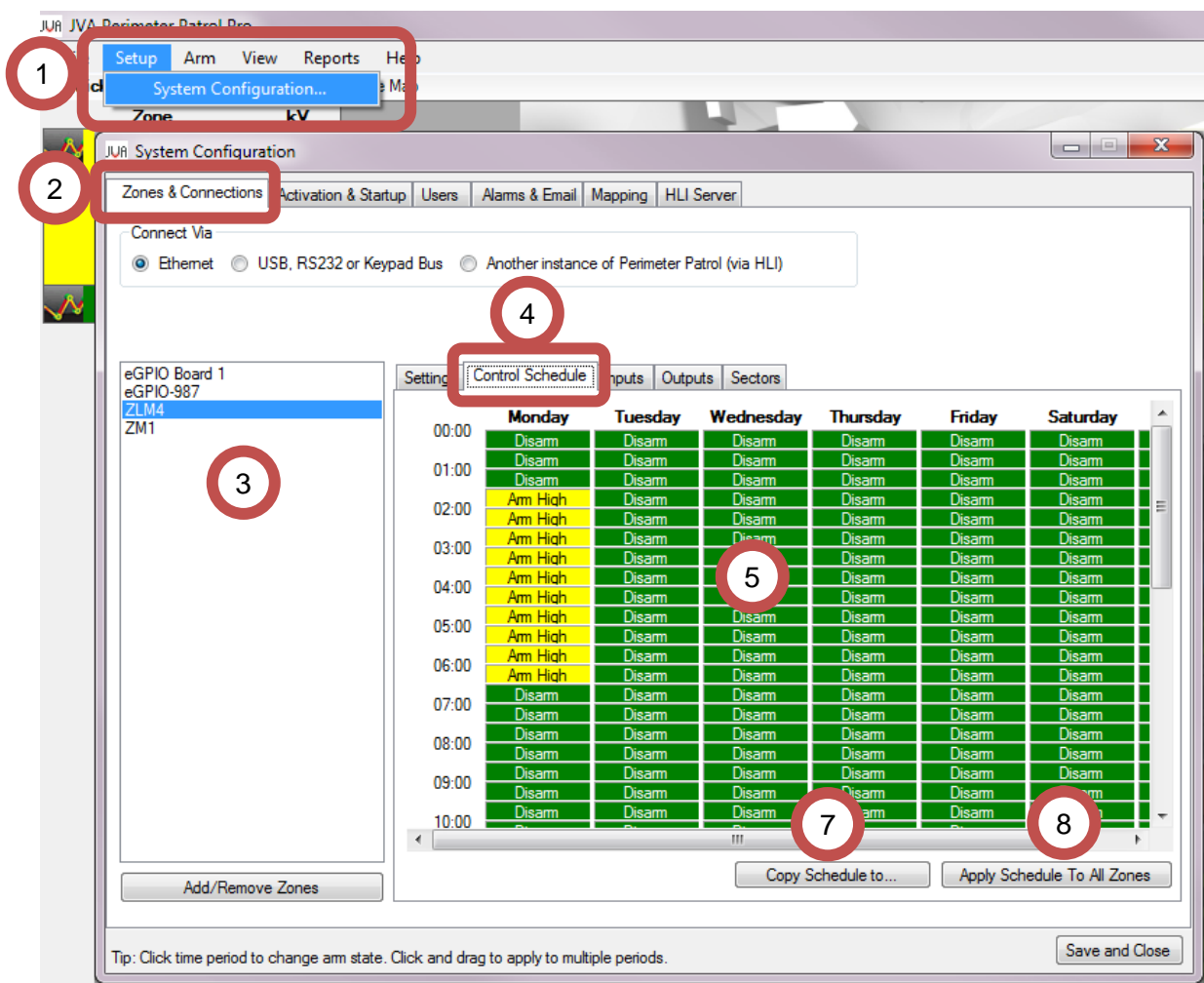

Figure 43 - Setting the control schedule for a zone

## 6.5 Selecting Map Image

### 6.5.1 Selecting the Map

With zones added to JVA Perimeter Patrol, you are ready to setup the map image that will be displayed to the system operators.

To setup the map image in JVA Perimeter Patrol, most system installers will use Google Earth to capture an aerial view of the site to be secured.

1. Save a copy of the site aerial view to your hard drive.
2. Click **Setup** → **System Configuration**
3. Select the **Mapping** tab
4. Click the **Browse** button and select the map image to be used in JVA Perimeter Patrol.

When you close the System Configuration window, JVA Perimeter Patrol's background map image will change to the image you selected.

You may notice two more buttons on this tab. The **Reset Zone Label Positions** button causes all the zone labels on the configuration map to be placed in their original position in the top left corner. The **Reset Zone Lines** button causes all the zone lines to be erased from the map. These buttons are a good way to quickly erase all your previous drawings so that you can start drawing the zones on the map image again.

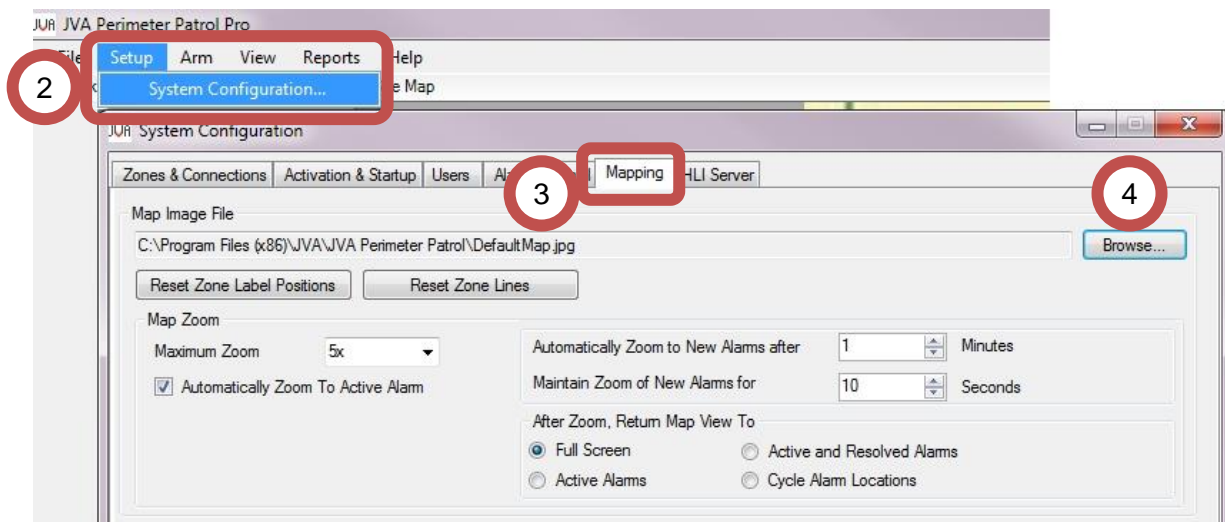

Figure 44 - Choosing a map image

### 6.5.2 Setting the Zoom Level for the Map

If your Map is a high resolution image and you have a lot of zones to be displayed, you may want to add some Zoom Levels to Perimeter Patrol.

1. Select the Maximum Zoom level you need. You may want to start at the highest (15x) level, draw your zone lines while zoomed in and then decide later what is acceptable

To zoom into a section of the map, you can use the slider at the top right side of the Map, or use the Mouse Scroll Wheel. When using the Scroll Wheel, the map will centre the zoom at the current cursor position in the map.

Moving around a Zoomed map is easy, there is a horizontal and vertical slide bar at the bottom and right side of the map. An easier way is to use the mouse by left clicking then dragging the map. This is similar to other Map systems you probably have already used.

2. Checking the Automatically Zoom To Active Alarm box will allow Perimeter Patrol to take control of the Zoom functionality
3. The zoom will only occur when the Mouse has been left idle for the specified time  
Any new alarm that occurs will be centred on the Map at the Maximum zoom level required to fit the entire Zone into the screen
4. This zoom level will be maintained for this specified time
5. After which, the map will return to either:  
Full Screen: The entire Map will be displayed  
Active Alarms: All of the Active Alarms will fill the Map View  
Active and Resolved Alarms: All open alarms will fill the Map View  
If the Full Screen Option is not chosen, then after the 'Idle' time (3), the Map will automatically return to Full Screen.

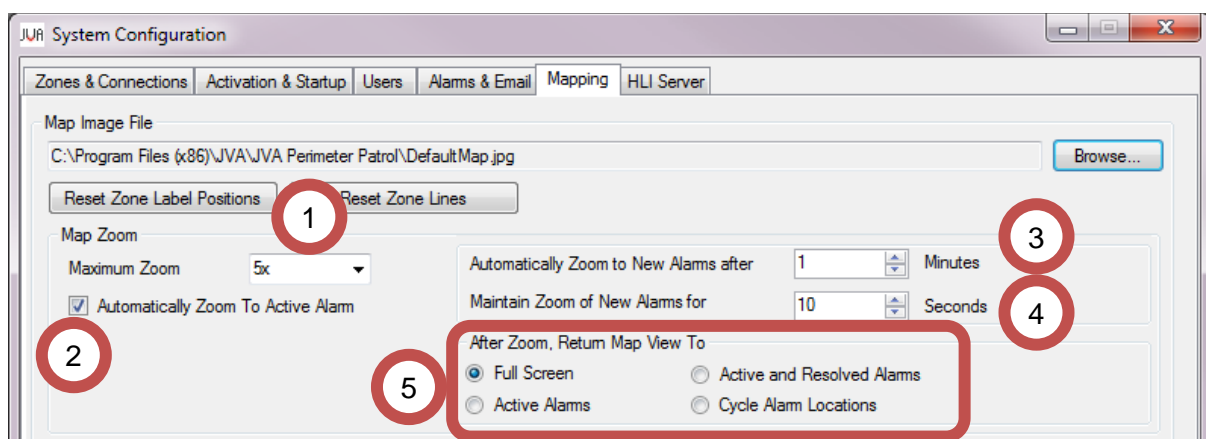
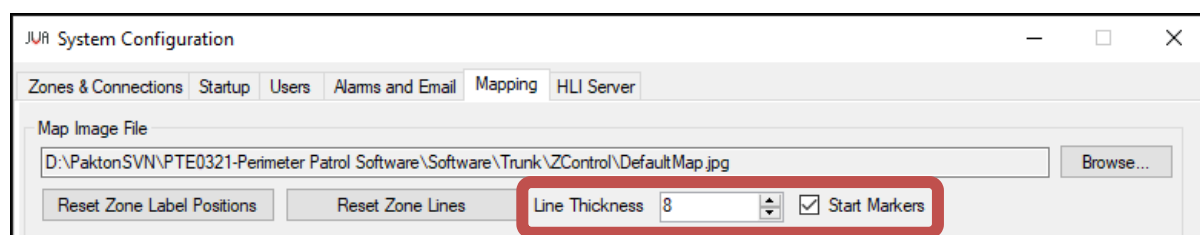

Figure 45 – Zoom settings

### 6.5.3 Setting the line thickness and start markers

You may find that the lines are a little too thin or thick on your map. You can increase or decrease the thickness of lines here. If the **Start Markers** option is checked, a small line perpendicular to the first point on a zone line is added to signify the start point of a zone. You can turn this on or off at any time.



## 6.6 Drawing zones on the map

With your zones configured and the map image correct, it's time for you to draw the zones on the map. You can do this on the actual map itself.

### Move the zone labels

Start by looking for the zone labels. They are usually all in the top left corner of the map. When you have found the labels, you can drag each of them to the appropriate place on the map. An example zone label is shown in the image below.

- Hold down the **Shift** key and drag the label with your mouse.

### Draw the zone lines

- Right-click on the zone label and select **Draw Line**
- Click on the map where you want the zone line to begin.
- Click at each point where the zone line should go to.
- Right-click at the final point to end the drawing session.



Figure 46 - Begin drawing zone lines by right-clicking on the zone label and selecting "Draw Line"



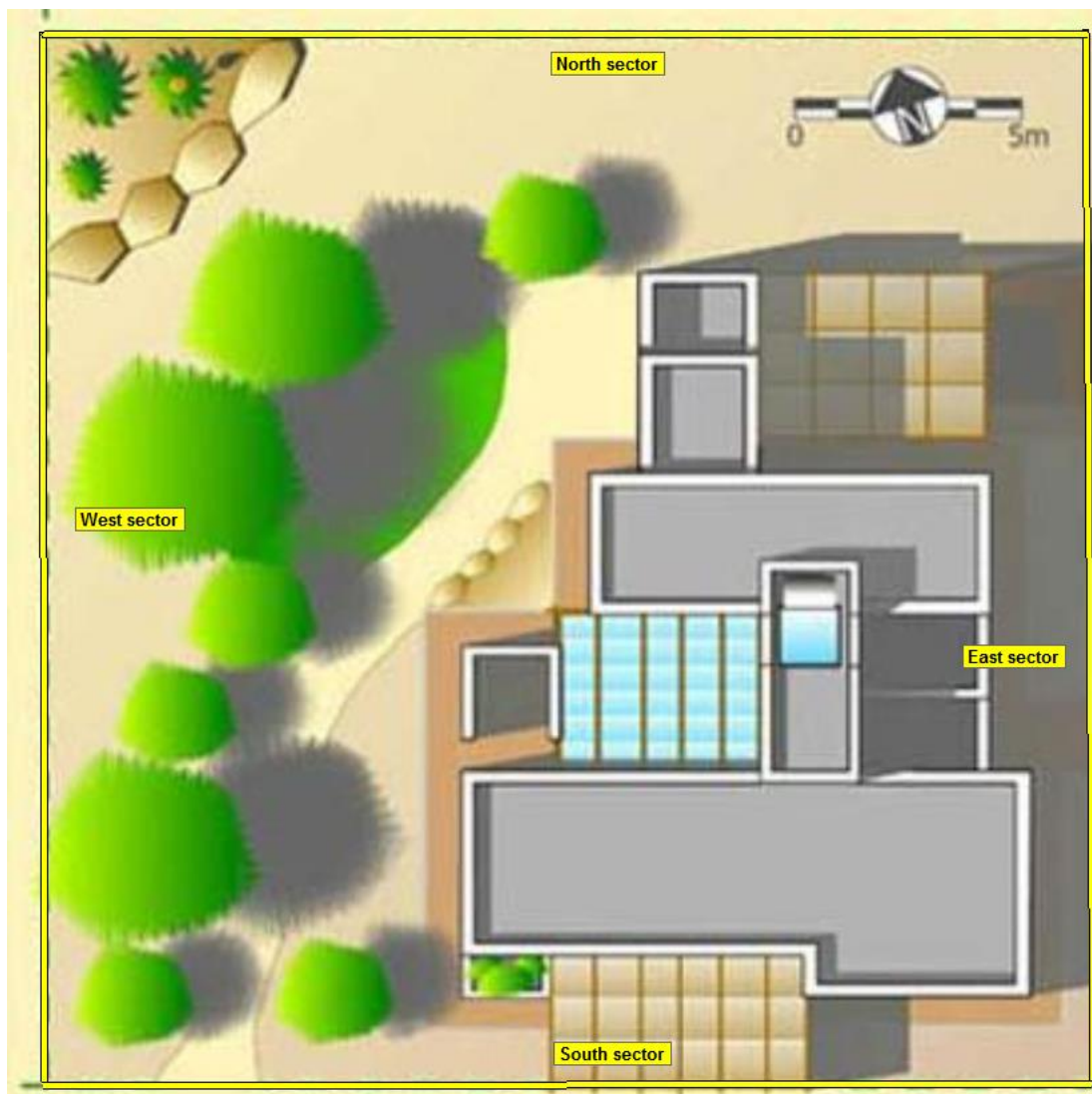

Figure 47 - Example zone lines drawn around the perimeter of an example site

## 7 Configuring Advanced Features

### 7.1 Configuring IO Boards with JVA Perimeter Patrol

Ethernet and General Purpose IO Boards are added to JVA Perimeter Patrol in the same way as zones.

If all inputs on an Ethernet IO Board are configured as digital inputs, then the board will show up as a single zone with a Keypad Bus ID of 1, and the name “Analog IO Expander”, a General Purpose IO board will have the name “In/Out Expander”

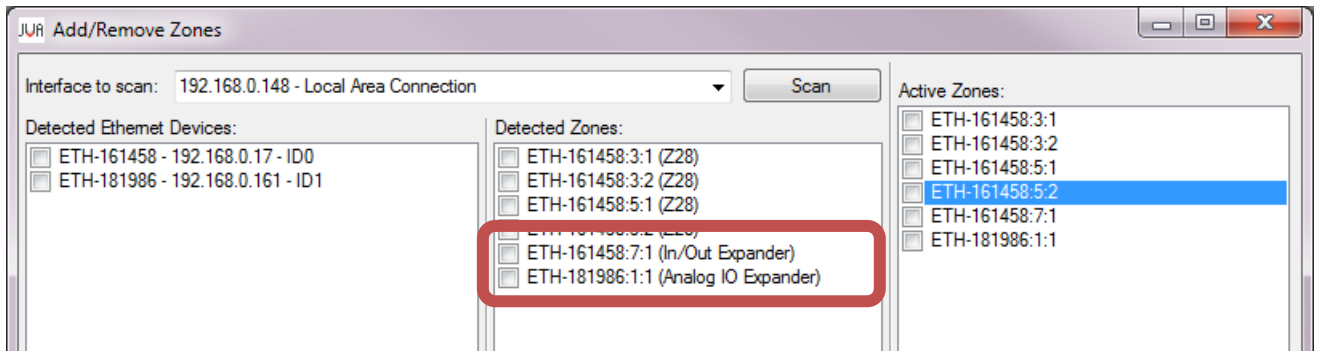

Figure 48 –IO Boards with all Digital Inputs

When one or more inputs on an Ethernet IO Board are configured as analog inputs (see the **Ethernet General Purpose IO Technical Manual**), each will be represented by a single zone with the Keypad Bus ID of 1. The Channel number of the zone will represent the analog input number. This will be followed by the device description of “Analog IO Expander”. The image below shows an Ethernet IO Board with inputs 2 and 3 configured as analog inputs:

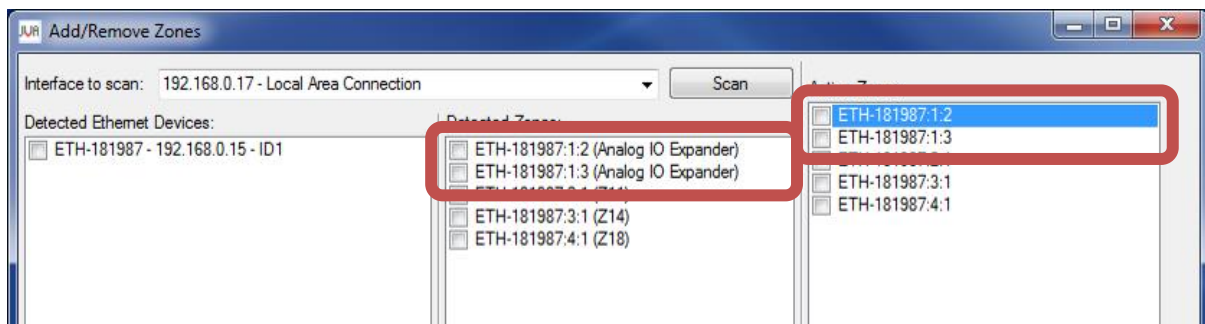

Figure 49 – Adding an Ethernet IO Board with inputs configured as analog inputs

Proceed to edit the zone details as you would for a normal electric fence zone, giving the zone a friendly name and ensuring that its other details are correct, and saving your changes (see Adding zones on page 47).



### 7.1.1 Configuring Analog Inputs

Inputs on the Ethernet IO Board that are configured as analog inputs can be used for measuring an external analog signal. This signal can generate alarms if it falls outside of a specified range. If you wish to use either of these functions:

- Click Setup → System Configuration
- Click Zones & Connections
- Select the zone corresponding to the desired analog input

On the Settings tab, the Analog Input Settings boxes can be used to adjust the offset, scaling factor and units of the input, allowing the measured value of the analog input to be adjusted to display the quantity it is measuring (e.g. temperature). The Alarm Thresholds settings can be adjusted to allow the analog input to generate an alarm if its value falls outside of the specified limits while the zone corresponding to the input is armed.

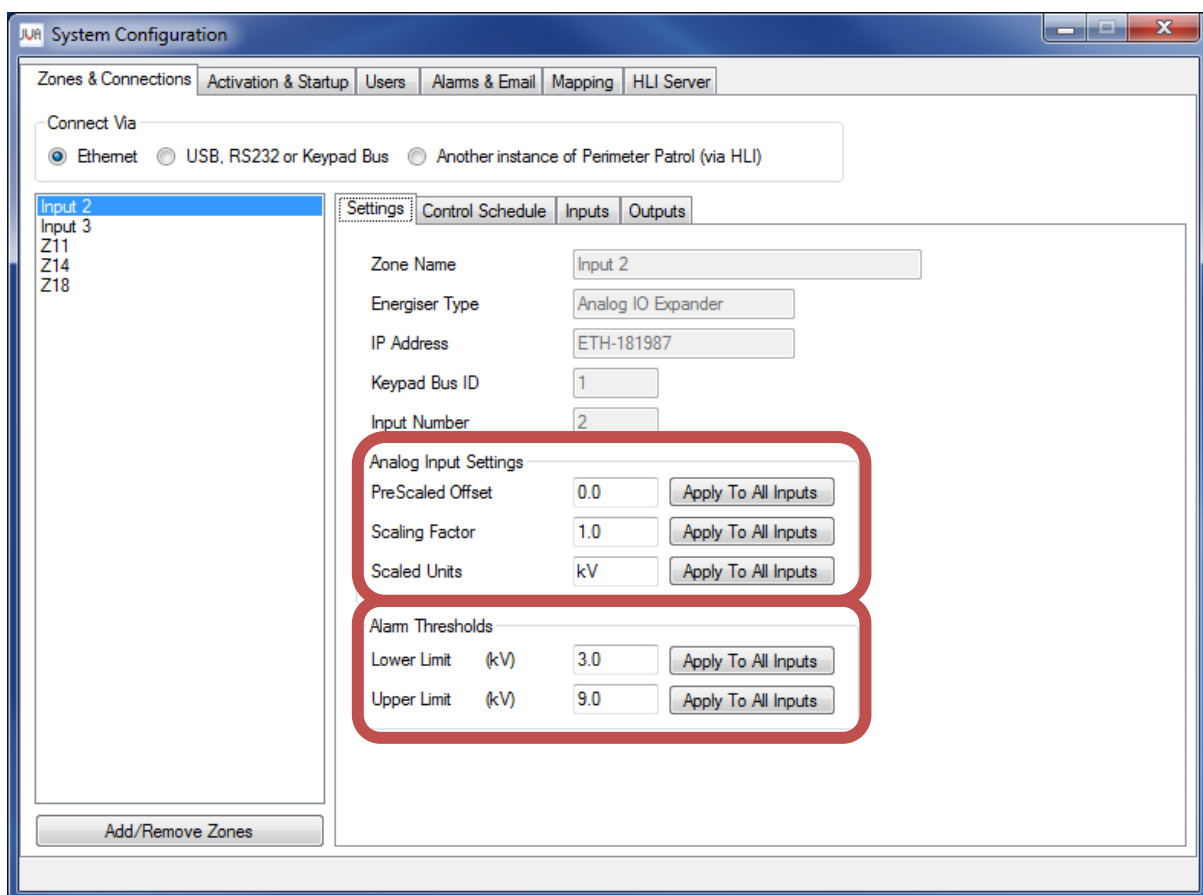

Figure 50 - Configuring IO Board Inputs

### 7.1.2 Configuring Digital Inputs

Digital inputs can be used for displaying input status on the map, generating alarms, or triggering functions within Perimeter Patrol. To configure an input:

1. Select a zone corresponding to the Ethernet IO Board.
2. Click the Inputs tab.
3. Click Add Input, and give this new input a friendly name.
4. Set the Input Number to the required Input number on this IO board.

If the input is configured for analog input, or if the input has already been added to another zone corresponding to the Ethernet IO Board (e.g. when there are multiple analog input zones), then the input will not work.

5. Select whether the input will be shown on the map, and select an option in the Input Generates Alarm box.

The “When Activated” option will generate an alarm whenever that input is activated. The “When Armed And Activated” option will only generate an alarm when the input zone is armed and the input is activated.

The example image below shows the zone named “IO Board 1” with digital input 1 named “Motion Sensor”. It has been configured to be displayed on the Map, and to Generate an Alarm when the zone “IO Board 1” is armed and the digital input “Motion Sensor” is activated.

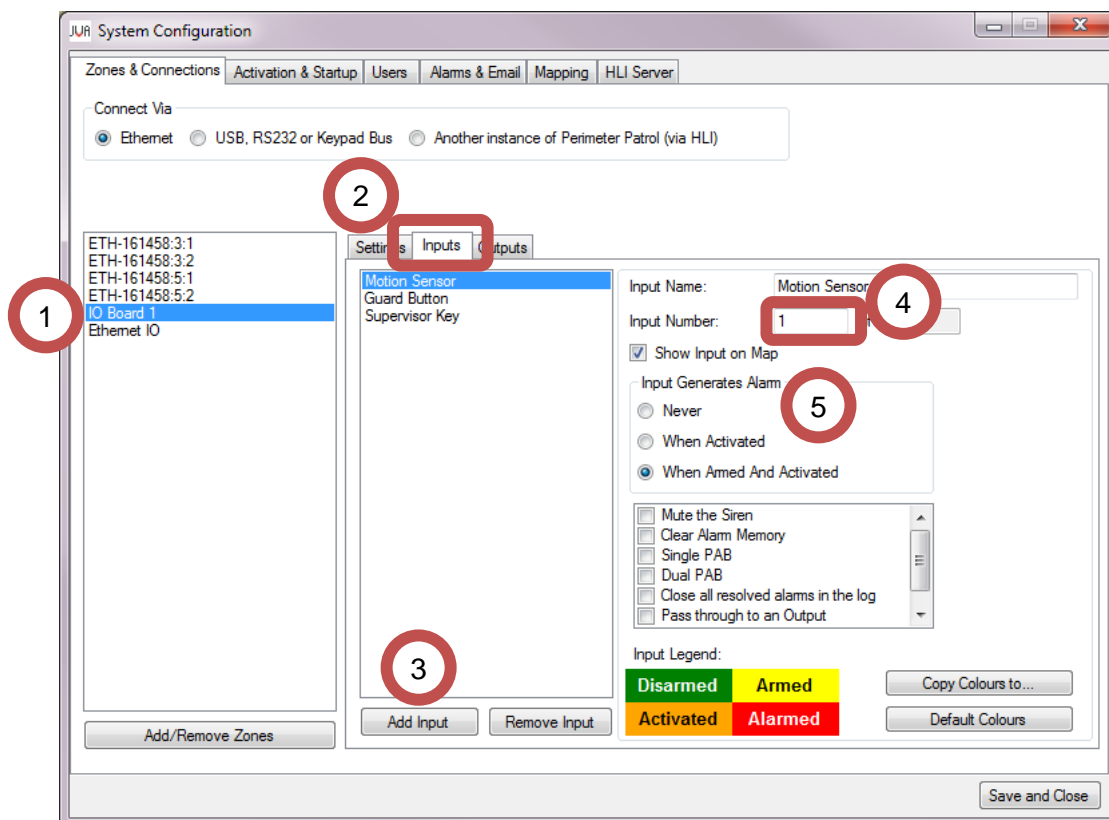

Figure 51 - Configuring IO Board Inputs

### 7.1.3 Digital Input Functions

Digital Inputs can perform one, or more, functions by “checking” the box next to the required Function Names. As most functions are not Alarm based, it is preferable to set the Generate Alarm function to “Never”.

**Mute the Siren:** This will perform the same function as the “Mute Active Alarms” button in Perimeter Patrol. It will only “Mute” the Computer Siren sound; it will not stop sirens connected to Energisers.

**Clear Alarm Memory:** This will perform the same function as the “Clear Alarm Memory” button in Perimeter Patrol.

**Close resolved alarms for zones:** This allows you to specify zone alarms that can be closed using this input. This can be useful for closing low priority alarms without requiring a supervisor password. The Event Log will state “Closed by PAB”

**Dual PAB:** This feature is not available

**Close all resolved alarms in the log:** Triggering this input will automatically close all resolved alarms in the log. The Event Log will state “Closed by PAB” as the closing note.

**Pass through to an Output:** This input will be able to control the output state of one or more Outputs connected to Perimeter Patrol. The ‘link’ from this Input to an Output is created at the Output itself.

When you add the Pass Through Input function, another window will appear with all of the available User Controlled Outputs. Select the Outputs you want to control with this input.

**Disarm and Bypass Zone:** When this Input is triggered, the specified Zone will automatically be disarmed. If this zone is being controlled via the scheduler, the required arm state will be ignored until the Input is reset. At this point, the zone will Arm or remain Disarmed depending on the scheduled requirement. This function can be combined with a Pass Through Output connected to a Strobe or Light which indicates the current state of the Bypassed Zone.

If this zone is not controlled by the scheduler, the zone will NOT re-arm automatically. The user will have to Arm the Zone manually via Perimeter Patrol.

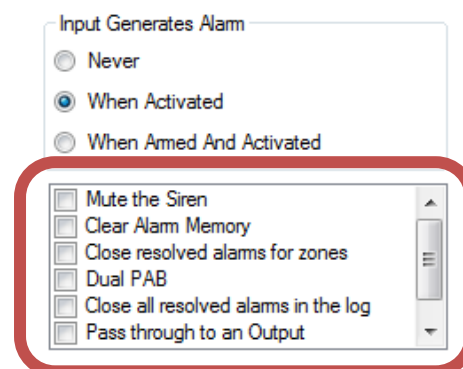

### 7.1.4 Configuring Outputs

Note: the Ethernet IO Board has all four outputs pre-configured to operate as HOST CONTROLLED. If these options are changed, the output will ignore commands from JVA Perimeter Patrol. The General Purpose IO board requires Outputs to HOST CONTROLLED

1. Select the zone (of an IO board) you want to 'attach' this output to.
2. Click the Outputs tab.
3. Click Add Output.
4. Set the Output Number to the output you want to control on the IO Board and update the Output Name
5. Set the Function Options:
  - Select either User Controlled or Function Controlled
  - Show Output on Map – this determines if the output will appear on the map
  - 'Tick' the function for the Output. More than one Function can be added. This may display a new window to select more information.
  - Log to Event Log on User Action – this determines if an Event Log entry will be created when the user activates or deactivates the output
  - Invert Output – this reverses the output On and Off states.

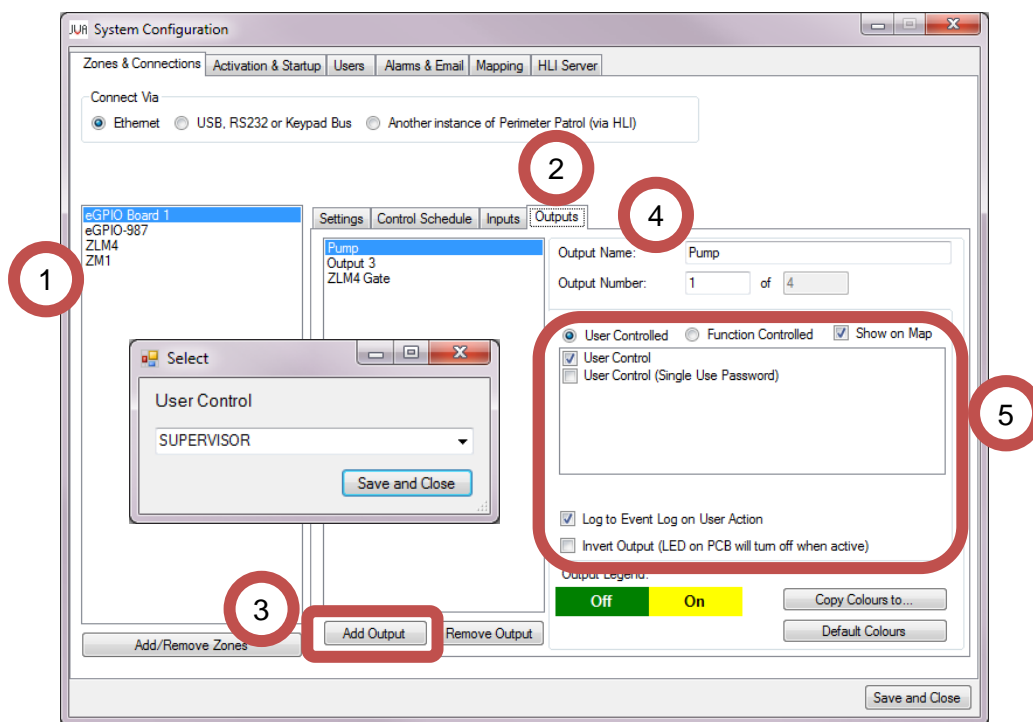

Figure 52 - Configuring IO Board outputs

In the example above, Output 1 was added to the eGPIO Board 1 and named “Pump”. The output will be displayed on the map and controlled by a Supervisor or above. It is also configured to create a log entry when the output changes state. This allows Supervisors and Administrators to control the Pump output by clicking on the output box labelled “Pump”. Each click is logged in the Event Log.

### 7.1.5 Output Function Descriptions

#### 7.1.5.1 User Control

User Control – This provides three permission levels of control (USER, SUPERVISOR, ADMIN). If the Current User does not have permission to control the Output, the Authentication Window will be displayed.

User Control (Single Use Password) – When this is chosen, the ADMIN can choose a unique password that will allow access to this Output. The output is ‘activated’ by clicking on the Output Box in the Map View at which point, the User is requested to enter the correct Password. The Password is not required to ‘deactivate’ the Output. This use of this Output cannot be re-activated until the ADMIN updates the Single Use Password in the System Configuration Window.

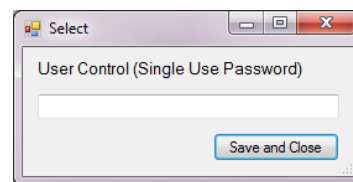

#### 7.1.5.2 Function Control

More than one Function can be selected to trigger an Output.

Input Controlled – This links the Output to one or more Inputs (pre-configured as Pass Through). The available Inputs will be displayed in a new window to be selected.

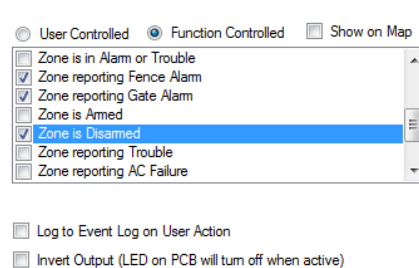

Any Alarm or Trouble on Site – This triggers the output if the Site has an Alarm or Trouble active

Computer Siren – This Output is triggered when the Perimeter Patrol Siren is sounding on the computer.

All Zones on Site are Armed – This Output will trigger when all Zones (including GPIO) are Armed. If one Zone is Disarmed, the output will deactivate.

Any Fence Alarm on Site – This Output is triggered when a Fence Alarm occurs on the Site. An Input Alarm will not trigger the Output.

Any Trouble on Site – Troubles include AC Fail, Low Battery, Battery Fault, Hardware Fault

Sector is in Alarm – The Output will trigger when the specific Sector is in Alarm. The sector is chosen in the window that is displayed when the “Function is Ticked”

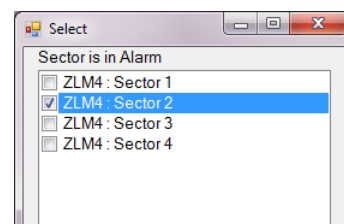

There are Various Functions that related to specific Zones and Triggers. The options available include: Alarm or Trouble; Fence Alarm; Gate Alarm; Armed; Disarmed; Any Trouble; AC Failure; Low Battery; Battery Fault; Hardware Fault. On each of these functions, the Zone to trigger this output can be selected in the window. The example to the right shows the Output triggering when the eGPIO Board 1 is Armed.

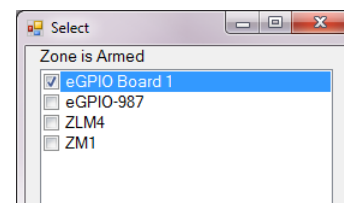

### 7.2 Zone/Sector/Input/Output Colours

Each item that can be represented on the Map can have its colours changed to suit the customer’s preference or to help specific items stand out from the others. To achieve this, select the Zone/Sector/Input or Output and click on the Zone Legend box you want to change.

This will open a new window where you can select the colour for this Legend. This new colour will be displayed in the Zone Legend, Quick View and Map. You can change up to 4 colours per item with the 16 million available colours in the ‘Colour Picker Window’

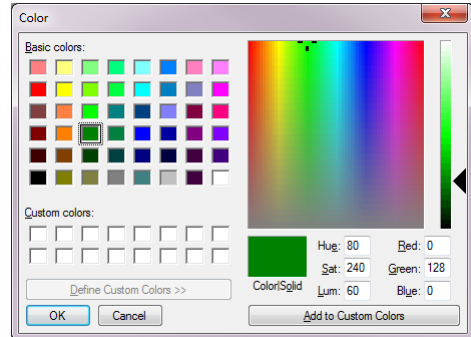

This new colour legend (all colours) can be copied to other Zones/Sectors/Inputs/Outputs by pressing the **Copy Colours To...** button. When the new window appears, select which items you want this copied to. Please note, the Zone Colours will only copy to other Zones, Sector colours will copy to other Sectors etc.

If you want to change back to the Default Colours, press the button. This will only default the currently selected Zone/Sector etc. You will have to use the **Copy Colours to...** button to transfer this to other Zones/Sectors etc.

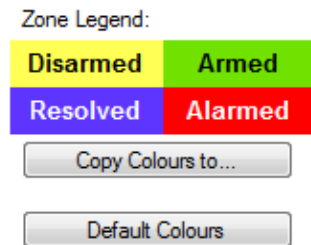

### 7.3 Alarm Popups

Each Zone, Input and Sector that generates an Alarm can trigger an Alarm Popup. The Popup can provide information about the Alarm Location, Preferred Security Response and any other useful information for the Security Guard. To create a Popup, select the Zone/Sector or Input on the Zones & Connections tab and Click on the Alarm Popup button.

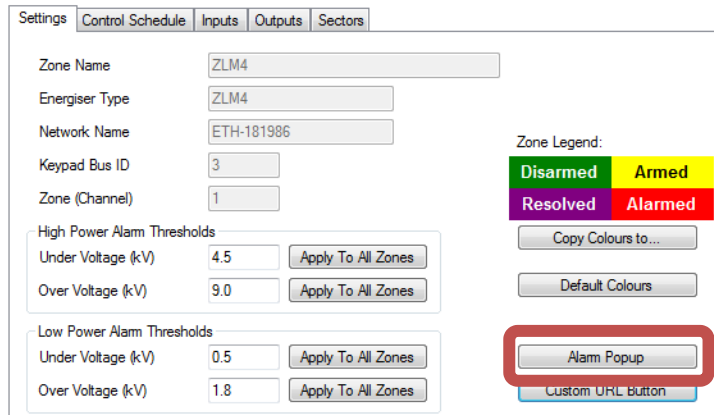

The Popup Configuration window will open. Type the useful information into the left side.

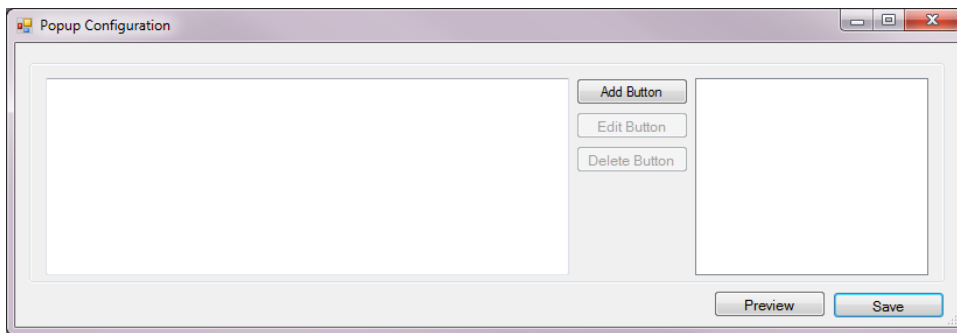

If the site has internet access, or has IP cameras accessible via a Web Interface, it may be beneficial to add a Button to the Popup. Click on **Add Button** to open the Custom URL window. More than one button can be added to an Alarm Popup and when finished, click on the **Save** Button to close the window.

Section 7.4 explains the configuration of the Buttons.



### 7.4 Custom URL (Hyperlink) Buttons

A Custom URL (Hyperlink) Button can be added to a Zone Popup box, or to Alarm Popups. This can be used to connect the user to a relevant Website Map, IP Cameras or any other site Web Interface. When clicked on, the Default Internet Browser will be opened to the URL address configured in the Button.

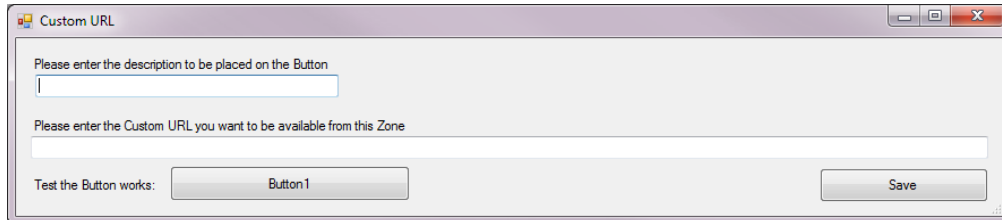

Enter the Description of the Button’s function into the top box and the hyperlink into URL textbox. Before pressing the Save Button, test the button by clicking on the Demo Button.

An easy way to determine the correct text for the Hyperlink is to open an Internet Browser, find the Web Page to be displayed and Copy the text directly from the Browsers Address Bar. Paste this into the URL textbox.



### 7.5 Map Icons

Each item (Zone/Sector/Input/Output) that is displayed on the map can have an Icon added above the Zone Label, or replace the Zone Label Entirely. Both Icons and labels can be rotated independently of one another. To add an icon, right click on the Zone Label and change the ‘Label’ option to either ‘Icon’ or ‘Label and Icon’.

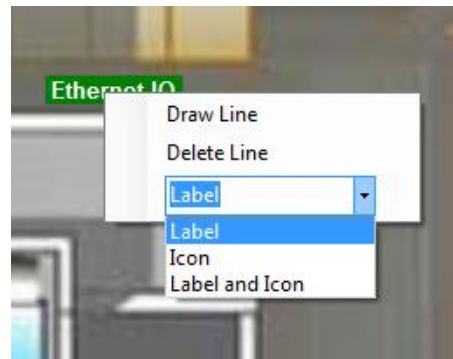

This will display a larger menu where you can select the Icon (Choose Icon) or change its size and rotation. Perimeter Patrol comes with a small set of icons for you to use, or you can provide your own images to use as the icons.

This is useful for providing a visual representation of the Zone/Input/Output rather than Description



a

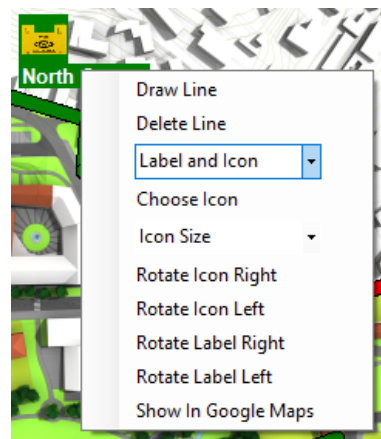

Finally, if you have configured



Longitude and Latitude coordinates, you can click **Show in Google Maps** to see the location in google maps.

## 8 Connecting two instances of Perimeter Patrol in Server / Client configuration using the HLI

### 8.1 Configuring Perimeter Patrol Server

Perimeter Patrol Server is the instance of Perimeter Patrol that connects directly to the JVA electric fence devices. It will act as a server when it accepts incoming connections from other instances of Perimeter Patrol and sends information to them.

#### 8.1.1 Configuring Perimeter Patrol Server to accept HLI connections

- Click **Setup -> System Configuration**
- Open the **HLI Server** tab
- Choose **HLI Server Enabled**
- Set the **TCP Listening Port** to a value between 1,000 and 10,000.
- Set a value for the **Authentication Key**. It doesn't matter what value you use for the Authentication Key during testing, but you should use the "Generate" button to make a complicated key for your production sites, because this key is like a password code that prevents unauthorized software from connecting to your Perimeter Patrol.
- Shut down and restart Perimeter Patrol Server as this is required for the new settings to take effect.

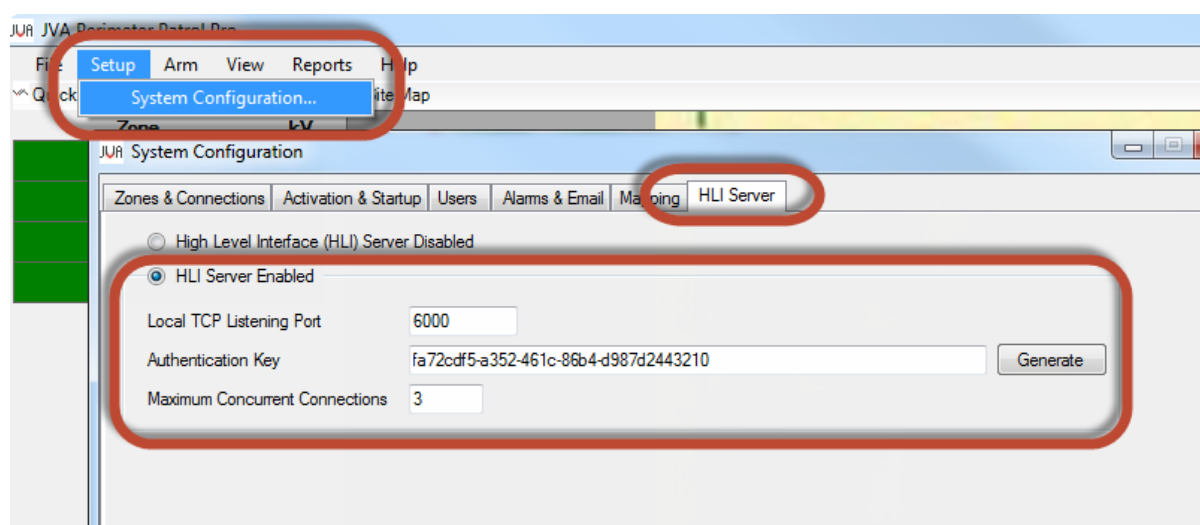

Figure 53 - Enabling HLI Server to accept HLI connections

#### 8.1.1.1 Use a static (fixed) IP Address for Perimeter Patrol

Ask your system administrator to configure your network router so that it assigns a static IP Address to the computer running Perimeter Patrol.

## 8.2 Configuring Perimeter Patrol Client

Now that Perimeter Patrol Server is setup and waiting for clients to connect, your best option is to now start Perimeter Patrol on a different computer and connect to the Server. Here's how to do that:

1. At the login prompt, click **Connection Settings**

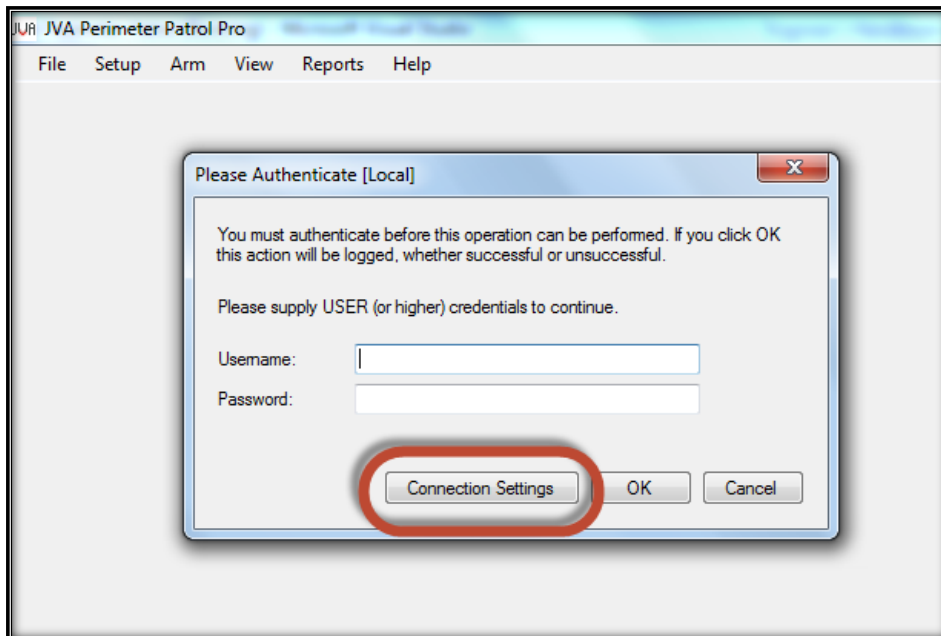

2. Choose **Connect to another instance of Perimeter Patrol via its HLI**.
3. Enter the **Remote Site Name** into the box.
4. Enter the IP Address of Perimeter Patrol Server, or a Domain Name that you have registered to connect to the Server. For example MermaidEstate.dyndns.org
5. Enter the Remote Port that you chose for Perimeter Patrol Server.
6. Enter the Authentication Key that you chose for Perimeter Patrol Server.
7. Press the **Save** Button
8. Press the **Save and Close** Button

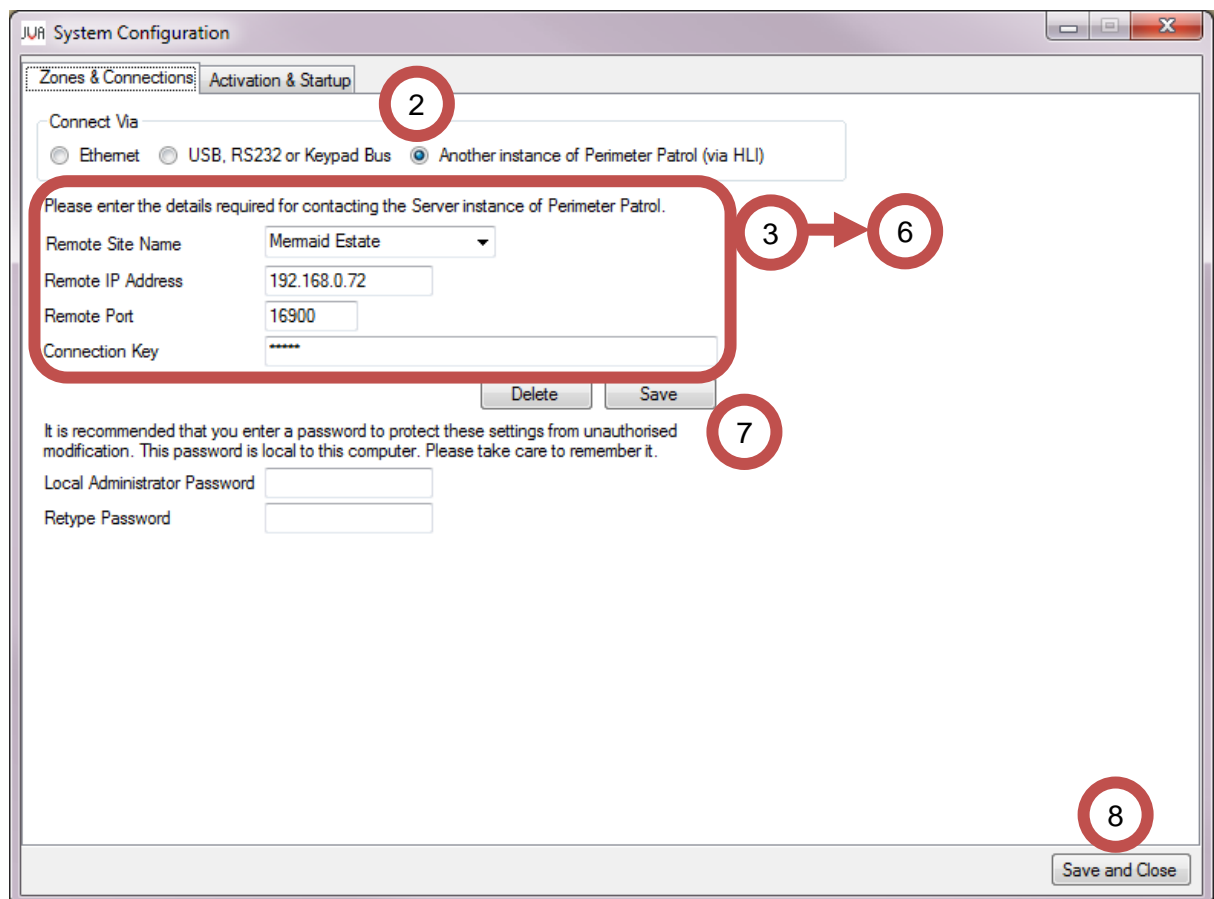

If you have more than one site that you will be connecting to, you can add more Remote Connection Details. After you press the Save Button, start entering the details of the next site. Ensure the Remote Site Name is different from other Sites, or the original will be saved over. Once the new Site details have been entered, press the Save Button again.

From now on, you can choose the site you want to visit by selecting the site from the Remote Site Name box. The IP, Port and Connection Key will automatically update to the selected site.

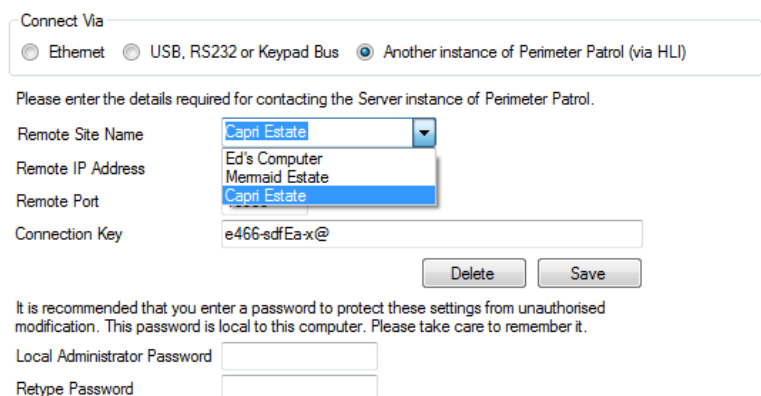

9. If the connection is successful, the Perimeter Patrol Client will ask you to enter username and password credentials for connecting to the Perimeter Patrol Server
10. Enter a username and password exactly as they were setup in the configuration of Perimeter Patrol Server, and click **OK**

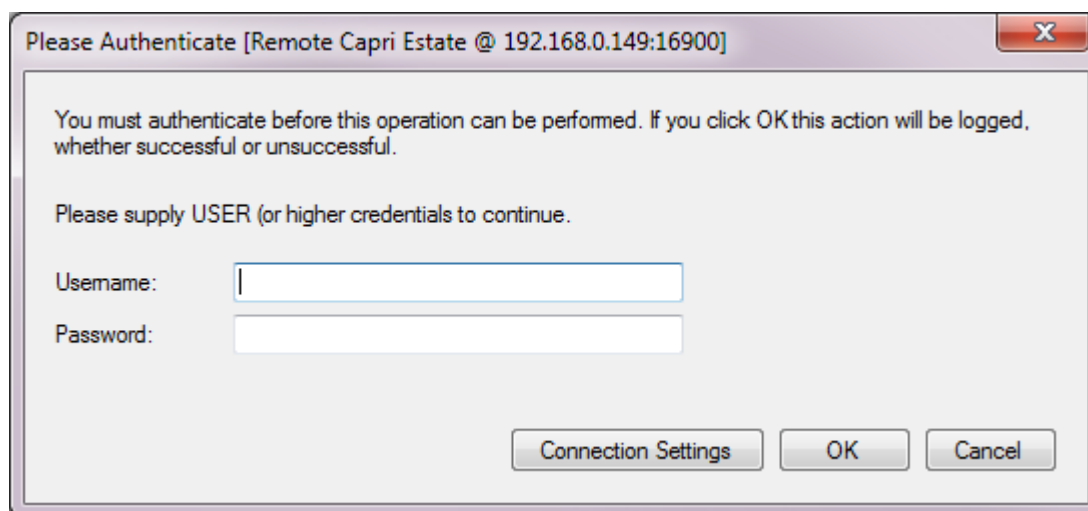
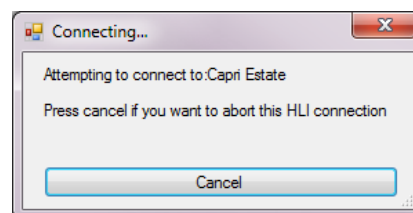

### 8.3 Using the correct IP Address and Port

While following the instructions above, were you able to establish a connection? If not, you may be entering the wrong IP Address and Port into Perimeter Patrol client.

Following are some instructions to help you use the correct IP Address and Port number. The requirements will differ depending on whether Perimeter Patrol Client is attempting to connect from the same Local Area Network (LAN) as Perimeter Patrol Server. The first section below will give instructions for the situation when both computers are connected to the same LAN. The next section will give instruction for the situation when Perimeter Patrol Client is in a different physical location and must connect using the internet.

### 8.3.1 Connecting Server and Client on LAN

Now that your system administrator has given Perimeter Patrol server a fixed IP Address, you can ask him for that address. Alternatively, you can find it out yourself. On the computer running Perimeter Patrol Server:

- Click **Start -> Run** and enter **cmd.exe**.
- If that doesn't work, enter **C:/windows/system32/cmd.exe**
- If you don't have "Run" on your start menu, you can find C:/windows/system32/cmd.exe in explorer and double-click the file to start it.
- The window pictured below will open.
- Type **ipconfig** and press Enter.
- Write down the IPv4 address. This is the IP Address that your client software needs to know.
- Your computer will have more than one IPv4 address if it has more than one network adapter device. Choose the address corresponding to the correct network adapter device.

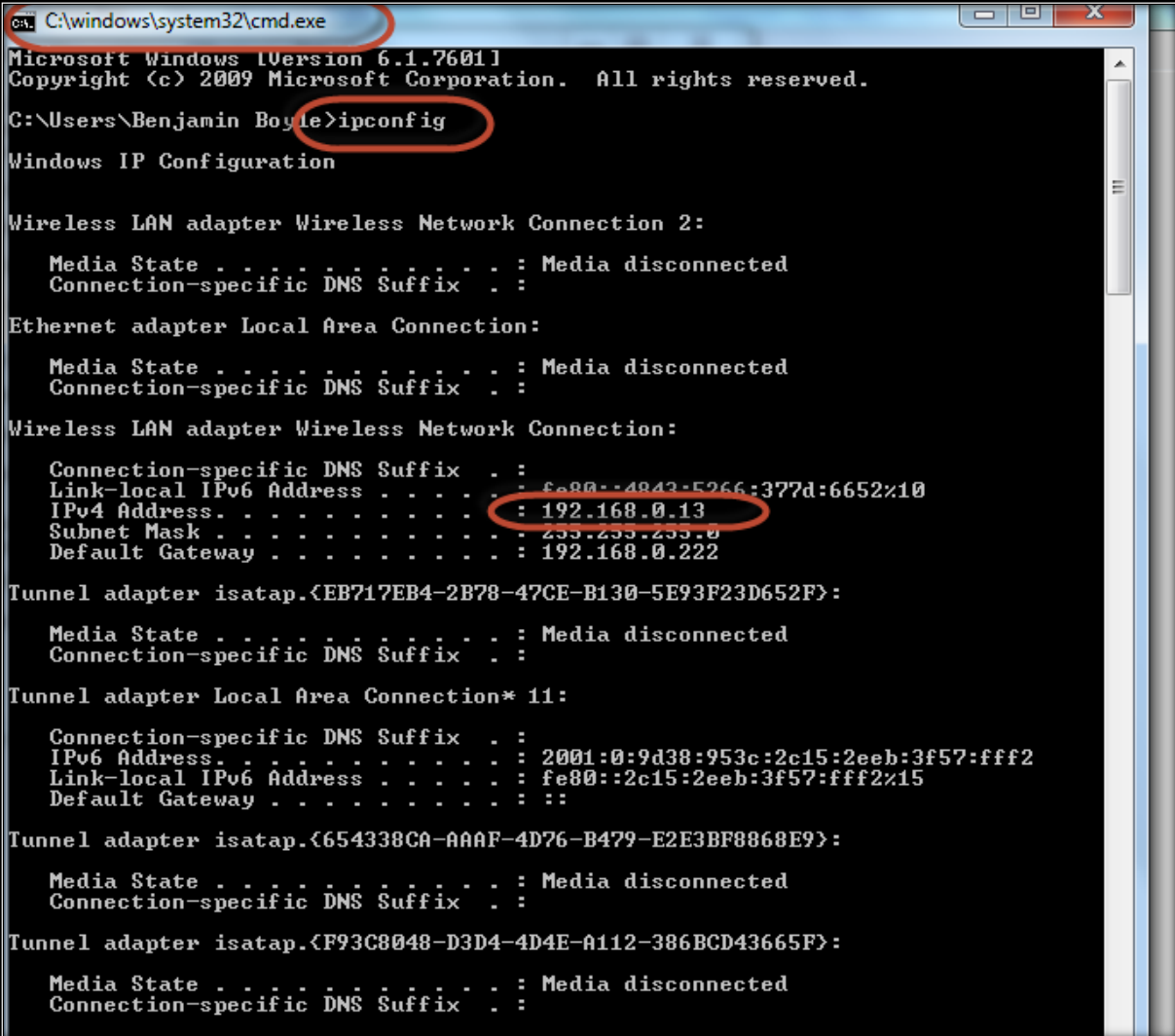

```
cmd: C:\windows\system32\cmd.exe
Microsoft Windows [Version 6.1.7601]
Copyright (c) 2009 Microsoft Corporation. All rights reserved.

C:\Users\Benjamin Boyle>ipconfig

Windows IP Configuration

Wireless LAN adapter Wireless Network Connection 2:

    Media State . . . . . : Media disconnected
    Connection-specific DNS Suffix . :

Ethernet adapter Local Area Connection:

    Media State . . . . . : Media disconnected
    Connection-specific DNS Suffix . :

Wireless LAN adapter Wireless Network Connection:

    Connection-specific DNS Suffix . :
    Link-local IPv6 Address . . . . . : fe80::4843-f266-377d:6652%10
    IPv4 Address. . . . . : 192.168.0.13
    Subnet Mask . . . . . : 255.255.255.0
    Default Gateway . . . . . : 192.168.0.222

Tunnel adapter isatap.<EB717EB4-2B78-47CE-B130-5E93F23D652F>:

    Media State . . . . . : Media disconnected
    Connection-specific DNS Suffix . :

Tunnel adapter Local Area Connection* 11:

    Connection-specific DNS Suffix . :
    IPv6 Address. . . . . : 2001:0:9d38:953c:2c15:2eeb:3f57:fff2
    Link-local IPv6 Address . . . . . : fe80::2c15:2eeb:3f57:fff2%15
    Default Gateway . . . . . : ::

Tunnel adapter isatap.<654338CA-AAAF-4D76-B479-E2E3BF8868E9>:

    Media State . . . . . : Media disconnected
    Connection-specific DNS Suffix . :

Tunnel adapter isatap.<F93C8048-D3D4-4D4E-A112-386BCD43665F>:

    Media State . . . . . : Media disconnected
    Connection-specific DNS Suffix . :
```

Figure 54 - Finding out the computer's static IP Address on the LAN

### 8.3.2 Connecting Server and Client on WAN

After creating a static IP Address for Perimeter Patrol Server, your system administrator will have to configure the network router by adding a NAT record to allow outside computers to directly connect to the Perimeter Patrol server.

Be sure to tell your network administrator to point the NAT record to the same port as Perimeter Patrol Server is configured to use as the TCP Listen port.

The network administrator will inform you of the IP Address and Port you should use.

You will need to know the IP Address of the router as seen from the internet outside. If the network administrator forgets to give you this value, you can use <http://www.whatismyip.com/> to get that information yourself, but you depend on the network administrator to know the port that he used for the NAT record.

Creating this opening to the outside network can be a security risk for Perimeter Patrol Server as people with malicious intent can cause a “brute force” attack on Perimeter Patrol whereby they try to shut it down by simultaneously launching thousands of connection requests.

Configure your router to block such attacks.

## 9 Locking down the computer to keep JVA Perimeter Patrol secure

As system administrator, you need to ensure the computer hosting JVA Perimeter Patrol is locked down giving the user limited ability to accidentally or deliberately sabotage JVA Perimeter Patrol.

Install and configure security software appropriate to the Windows version in use to achieve the following:

- Don't allow users to run any other application.
- Don't allow users to modify or delete files in the C:/ProgramData/JVA Perimeter Patrol directory.
- Don't allow users to run Task Manager or use other administrative tools to close the JVA Perimeter Patrol application.
- Ensure that JVA Perimeter Patrol starts up with the computer restarts.
- Don't allow users to shut down the computer, log off or switch user.

Consider the following requirements when installing the network and system hardware:

- Don't allow users to disconnect anything from the computer itself – secure the computer where the user can't access the cables attached to it.
- Don't allow users to access the Local Area Network. Keep routers and wiring inaccessible. Lock down the routers to prevent unauthorized access or modification to the LAN settings.
- If the LAN is wireless, make sure nobody knows the password.